

MOTORRAD ZUBEHÖR

ACCESSOIRES POUR MOTO

MOTORCYCLE ACCESSORIES

XDB500H  2015-

Lucas



D**GB****FR****CZ****ES****GR****PL****RU****TR****i**

Fußrasten-anlagen	Rearset	Kits de commandes reculées	Stupačky	Instalaciones reposapiés	Εξοπλισμός υποστηρίγματος ποδιών	Podnóżki	Подножки	Ayak mesnet donanımları
Fußrasten-Adapterplatten	Footrest adjuster plate	Platines de réglage pour commandes reculées	Adaptérové desky stupaček	Placa adaptadora de reposapiés	Υποστηρίγματα ποδιών-Πλάκες προσαρμογέα	Płyty adapterów podnóżka	Адаптеры для подножек	Ayak mesnedi adaptör plakaları
Austausch-Fußrastengelenk	Footrest pivots	Supports de repose-pieds	Výměna – kloub stupačky	Sustitución articulación reposapiés	Αντικατάσταση-Αρθρωση υποστηρίγματος ποδιού	Wymienny przegub podnóżka	Шарниры подножек для замены	Ayak mesnet mafsalı deđiştirme
Lenker-Modell	Handlebar model	Types de guidons	Model řídítek	Modelo manillar	Μοντέλο τιμονιού	Model kierownicy	Тип руля	Kol Modeli
Lenkerenden Standard	Bar Ends Standard	Embouts pour guidons standard	Koncovky řídítek Standard	Extremos manillar estándares	Άκρες τιμονιού Standard	Końcówki kierownicy standard	Наконечники руля „стандарт“	Kol uçları Standart
Classic	Classic	classiques	Classic	clásicos	Classic	Classic	„классик“	Klasik
Durchmesser	Diameter	Diamètre	Průměr	Diámetro	Διάμετρος	Średnica	Диаметр	Çapı
Basis-Set	The basic set	Le kit de base	Základní sada	Set básico	Βασικό σετ	Zestaw podstawowy	Базовый комплект	Temel Set
Distanzhülsen	Spacer sleeves	Les entretoises	Distanční objímky	Casquillos distanciadores	Χιτώνια απόστασης	Tulejki dystansowe	Распорные гильзы	Mesafe kovanları
Bremshebel	Brakelever	Levier des frein	Brzdová páka	Maneta de freno	Μανετα φρενου	Dźwignia hamulca	Тормозной рычаг	Fren kolu
Kupplungshebel	Clutchlever	Levier des embrayage	Páka spojky	Maneta de embrague	Μανετα αμπραγιαζ	Dźwignia sprzęgła	Рычаг сцепления	Debriyaj kolu
Tieferlegung	Suspension Lowering Kit	Biellette de suspension	Snížení	Descenso parte trasera	Χαμηλή ρύθμιση ανάρτησης	Obniżenie zawieszenia	Уменьшение высоты	Alt kalıp
Heckhöherlegung	Suspension Jack Up Kit	Correcteur de hauteur de selle	Zvýšení zádě	Elevación parte trasera	Υψηλή ρύθμιση πίσω ανάρτησης	Podwyższenie tyłu	Увеличение высоты задка	Arka üst kalıp
Veränderung nach unten	Downward adjustment	Changement vers le bas	Změna dolů	Modificación hacia abajo	Αλλαγή προς τα κάτω	Zmiana w dół	Изменение вниз	Deđişim aşığıya
Veränderung nach oben	Upward adjustment	Changement vers le haut	Změna nahoru	Modificación hacia arriba	Αλλαγή προς τα επάνω	Zmiana do góry	Изменение вверх	Deđişim yukarıya
Kennzeichenhalter	Registration plate holder	Support de plaque	Držák označení	Soporte matrícula	Στήριγμα πινακίδας	Wspornik tablicy rejestracyjnej	Держатель номерного знака	Plaka tutucusu
Kettenschützer	Chain guards	Protection de chaîne	Chránič řetězu	Protector de la cadena	Προστατευτικά αλυσίδας	Ostona łańcucha	Кожух цепи	Zincir koruyucu





FUSSRASTENANLAGEN

SYSTÈMES DE REPOSE-PIEDS
REAR SETS

RACING RASTENANLAGEN

SYSTÈMES DE REPOSE-PIEDS RACING REAR SETS FOR RACING

» BLACK EDITION – Fußrastenanlagen

- » hochwertige Rastenanlagen für ambitionierte Sportfahrer „made in Germany“
- » mit CNC gefräste Anlagen, schwarz eloxiert und vormontiert
- » individuelle Verstellmöglichkeiten
- » Umkehrschaltung ohne großen Aufwand möglich
- » superleichte Ausführung ab ca. 700 Gramm
- » Racingrasten inkl. Teflonstopfen
- » Verstellbereich von: 28,5 mm → und 18 mm ↑

BLACK EDITION – Rear Sets

- » high-grade rear sets for ambitious racing drivers “made in Germany”
- » with CNC-milled units, anodised black and pre-assembled
- » individual adjustment options
- » reversing shift pattern also possible with no major effort
- » extremely light model from approximately 700 grammes
- » racing foot rests including Teflon bungs
- » adjustable: 28.5 mm → and 18 mm ↑

BLACK EDITION – Systèmes de repose-pieds

- » repose-pieds de qualité supérieure pour les conducteurs sportifs ambitieux « fabriqué en Allemagne »
- » avec équipements fraisés par CNC, anodisés noir et prémontés
- » possibilités de réglage personnalisé
- » connexion par couplage inversé possible sans grandes difficultés
- » modèle ultraléger à partir de 700 grammes
- » repose-pieds racing, y compris embouts en téflon
- » ajustable: 28,5 mm → et 18 mm ↑

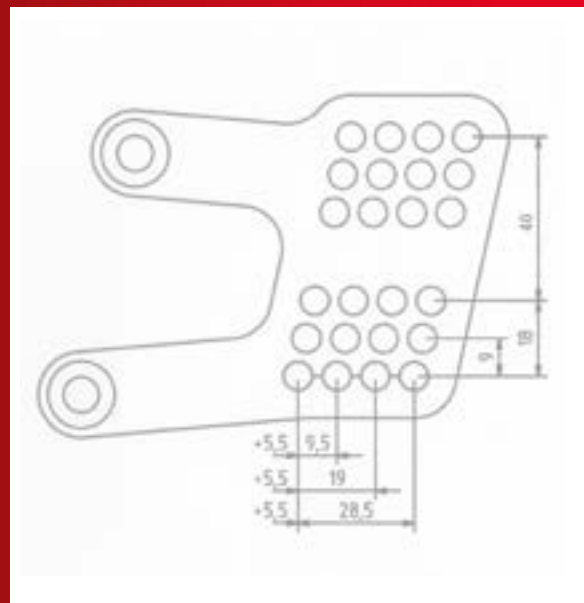

Beispiel Verstellbereich

Example for adjustment range

Exemple de plage de réglage

EINBAUBEISPIEL EXEMPLES D'INSTALLATION INSTALLATION EXAMPLES



Mit TÜV-Gutachten!

TÜV approved!

Homologué TÜV!

**Einbaubeispiel Suzuki GSX-R 1000
MCF 188 RAC**

*Installation example for
Suzuki GSX-R 1000
MCF 188 RAC*

*Exemple de montage sur
Suzuki GSX-R 1000
MCF 188 RAC*



**Einbaubeispiel Kawasaki Z 750 / Z 1000
MCF 115 RAC**

*Installation example for
Kawasaki Z 750 / Z 1000
MCF 115 RAC*

*Exemple de montage sur
Kawasaki Z 750 / Z 1000
MCF 115 RAC*



**Einbaubeispiel Ducati 1098 / 1198
MCF 118 RAC**

*Installation example for
Ducati 1098 / 1198
MCF 118 RAC*

*Exemple de montage sur
Ducati 1098 / 1198
MCF 118 RAC*



**Aprilia**

RSV	1000	Mille	ME / RP	98-03	MCF106RAC	Typ 1	System 1	1), 8)
RSV	1000	R	RR	04-	MCF107RAC	Typ 1	System 1	1), 17)
RSV	1000	R Tuono	RR	06-10	MCF107RAC	Typ 1	System 1	1)
RSV4	1000	R APRC, Factory, ABS	RK	09-	MCF108RAC	Typ 1	System 1	2), 19), bei ABS: 4) - MCH...
V4	1000	R Tuono APRC, ABS	TY	11-	MCF108RAC	Typ 1	System 1	2), 19), bei ABS: 4) - MCH...

BMW

S	1000	RR		09-13	MCF102RAC	Typ 4	System 4	7), 14), 15)
S	1000	RR		09-13	MCF102RAC-UM	Typ 3	System 2	9), 14), 16)
S	1000	R		14-	MCF102RAC	Typ 4	System 4	7), 14), 15)
S	1000	R		14-	MCF102RAC-UM	Typ 3	System 2	9), 14), 16)
S	1000	RR		15-	MCF100RAC	Typ 3	System 2	2)

Ducati

696	Monster, ABS	M5	07-	MCF110RAC	Typ 1	--	6), 15), 19)
796	Hypermotard	B1	09-12	MCF109RAC	Typ 4	--	16)
796	Monster, S, ABS	M5	10-	MCF110RAC	Typ 1	--	6), 15), 19)
848		H6	08-10	MCF118RAC	Typ 1	System 1	1)
848	Evo	H6	10-13	MCF118RAC	Typ 1	System 1	
1098	, S, R	H7	07-09	MCF118RAC	Typ 1	System 1	1), 19)
1100	Monster, S, ABS	M5	08-	MCF110RAC	Typ 1	--	6), 15), 19)
1100	Hypermotard, S	B1	07-12	MCF109RAC	Typ 1	--	6), 15)
1100	Hypermotard Evo, Evo SP		10-	MCF109RAC	Typ 1	--	6), 15)
1198	, S, R, SP	H7	08-	MCF118RAC	Typ 1	System 1	1), 19)
1199	Panigale, S, R	H8	12-	MCF111RAC	Typ 1	--	15)

Honda

CBR	125	R	JC50	11-	MCF114RAC	Typ 1	System 1	
CBR	500	RA	PC44	13-	MCF125RAC	Typ 2	--	15), 16), bei ABS: 4) - MCH35FR
CBR	600	F	PC35	99-08	MCF128RAC	Typ 1	System 1	
CBR	600	RR	PC37	03-06	MCF194RAC	Typ 1	System 4	3)
CBR	600	RR	PC40	07-08	MCF194RAC	Typ 1	System 4	3)
CBR	600	RR, RA	PC40	09-12	MCF194RAC	Typ 1	System 4	9), bei ABS: 4) - MCH70FR
CBR	600	RR, RA	PC40	13-	MCF194RAC	Typ 1	System 4	9), bei ABS: 4) - MCH70FR
CBR	900	RR	SC44	00-02	MCF191RAC	Typ 1	System 1	
CBR	900	RR	SC50	02-03	MCF191RAC	Typ 1	System 1	
CBR	1000	RR	SC57	04-07	MCF195RAC	Typ 2	System 2	3)
CBR	1000	RR, ABS	SC59	08-	MCF116RAC	Typ 2	System 2	Bei ABS: 4) - MCH20FR
CB	1000	R, RA	SC60	08-	MCF119RAC	Typ 2	--	2), 15), bei ABE: 4) - MCH40FR

Kawasaki

ZX-6R	600	RR	ZX600N	05-06	MCF198RAC	Typ 1	System 1	Bei ABS: 4) - MCH25FR
ZX-6R	636	Ninja	ZX636C	05-06	MCF198RAC	Typ 1	System 1	Bei ABS: 4) - MCH25FR
ZX-6R	600	Ninja	ZX600P	07-08	MCF198RAC	Typ 1	System 1	Bei ABS: 4) - MCH362H1
ZX-6R	600	Ninja	ZX600R	09-12	MCF198RAC	Typ 1	System 1	2), 4) - MCH282H1
ZX-6R	636	Ninja ABS	ZX600E	12-	MCF133RAC	Typ 1	System 1	Bei ABS: 4) - MCH75FR
Z	750	, ABS	ZR750L	07-	MCF115RAC	Typ 1	System 1	Bei ABS: 4) - MCH45FR
Z	1000	, ABS	ZRT00B	07-09	MCF115RAC	Typ 1	System 1	Bei ABS: 4) - MCH45FR
Z	1000		ZRT00D	10-	MCF172RAC	Typ 1	System 1	
Z	1000	SX	ZXT00G	10-13	MCF172RAC	Typ 1	System 1	
ZX-10	1000	Ninja	ZXT00E	08-10	MCF117RAC	Typ 1	System 1	
ZX-10	1000	, ABS	ZXT00F	10-	MCF173RAC	Typ 1	System 1	10), bei ABS: 4) - MCH90FR

Suzuki

GSX-R	600		AD	96-00	MCF183RAC	Typ 1	System 1	18)
GSX-R	600		VWBG	01-03	MCF183RAC	Typ 1	System 1	18)
GSX-R	600		VWB2	04-05	MCF183RAC	Typ 1	System 1	
GSX-R	600		VWCE	06-07	MCF187RAC	Typ 3	System 3	
GSX-R	600		VWCV	08-10	MCF187RAC	Typ 3	System 3	
GSX-R	600		VWC3	11-	MCF189RAC	Typ 3	System 3	
GSF	600	Bandit	GN77B	94-99	MCF145RAC	Typ 1	System 1	18)
GSF	600	Bandit	VVA8	00-04	MCF145RAC	Typ 1	System 1	18)
GSF	650	Bandit	VVB5	05-06	MCF145RAC	Typ 1	System 1	
GSF	650	Bandit	VVCJ	07-	MCF113RAC	Typ 2	--	15)

GSX	650	FA	VVCJ	08-	MCF113RAC	Typ 2	—	15)
SV	650		AV111	98-02	MCF181RAC	Typ 1	System 1	18)
SV	650		VVBY	03-	MCF181RAC	Typ 1	System 1	
GSR	750	, ABS	VVC5	11-	MCF182RAC	Typ 1	System 1	
GSX-R	750		VVBD	00-03	MCF183RAC	Typ 1	System 1	18)
GSX-R	750		VVB3	04-05	MCF183RAC	Typ 1	System 1	
GSX-R	750		VVCF	06-07	MCF187RAC	Typ 3	System 3	
GSX-R	750		VVCW	08-10	MCF187RAC	Typ 3	System 3	
GSX-R	750		VVC4	11-	MCF189RAC	Typ 3	System 3	
GSX-S	1000	, F	DG	15-	MCF184RAC	Typ 1	System 1	
GSX-R	1000		VVBL	01-02	MCF183RAC	Typ 1	System 1	18)
GSX-R	1000		VVBZ	03-04	MCF183RAC	Typ 1	System 1	
GSX-R	1000		VVB6	05-06	MCF186RAC	Typ 1	System 1	
GSX-R	1000		VVCL	07-08	MCF196RAC	Typ 1	System 1	
GSX-R	1000		VVCY	09-	MCF188RAC	Typ 3	System 3	
SV	1000		VVBX	03-08	MCF181RAC	Typ 1	System 1	8), 11), bei ABS: 4) - MCH30FR
GSF	1200	Bandit	GV75A	96-00	MCF145RAC	Typ 1	System 1	18)
GSF	1200	Bandit	VVA9	01-05	MCF145RAC	Typ 1	System 1	18)
GSF	1200	Bandit	VVCB	06	MCF145RAC	Typ 1	System 1	
GSF	1250	Bandit	VVCH	07-	MCF113RAC	Typ 2	System 3	
GSX	1250	FA	VVCH	10-	MCF113RAC	Typ 2	System 3	
GSX	1300	Hayabusa	VVCK	08-	MCF166RAC	Typ 1	—	15)
GSX	1340	B-King	VVCR	08-	MCF163RAC	Typ 1	System 1	Bei ABS: 4) MCH55FR
Triumph								
	675	Daytona	D67LC	07-12	MCF197RAC	Typ 4	—	15)
	675	Daytona	D67LC	07-12	MCF197RAC-UM	Typ 3	System 3	5), 16)
	675	Street Triple	D67LD	07-12	MCF197RAC	Typ 4	—	15)
	675	Street Triple	D67LD	07-12	MCF197RAC-UM	Typ 3	System 3	5), 16)
	675	Street Triple, ABS	L67LR	13-	MCF190RAC	Typ 4	—	15), bei ABS: 4) - MCH50FR
	675	Street Triple, ABS	L67LR	13-	MCF190RAC-UM	Typ 3	System 3	16), bei ABS: 4) - MCH50FR
	675	Daytona R, ABS	H67	13-	MCF190RAC	Typ 4	—	15), bei ABS: 4) - MCH50FR
	675	Daytona R, ABS	H67	13-	MCF190RAC-UM	Typ 3	System 3	16), bei ABS: 4) - MCH50FR
	1050	Speed Triple, ABS	515NV	11-	MCF193RAC	Typ 1	—	15), bei ABS: 4) MCH...
Yamaha								
YZF	125	R	RE06	08-	MCF150RAC	Typ 4	—	15)
YZF	600	R6	RJ11	06-07	MCF169RAC	Typ 3	System 3	2)
YZF	600	R6	RJ15	08-	MCF169RAC	Typ 3	System 3	2)
	700	MT-07	RM04	14-	MCF103RAC	Typ 2	System 1	Bei ABS: 4) MCH65FR
FZ8	800	, Fazer 8, ABS	RN25	10-	MCF164RAC	Typ 4	—	15)
	850	MT-09	RN29	13-	MCF104RAC	Typ 2	System 1	
FZ1	1000	, Fazer	RN16	06-	MCF164RAC	Typ 4	—	7), 12), 15), 4) - MCH64FR
FZ1	1000	ABS, Fazer	RN16	06-	MCF164RAC	Typ 4	—	7), 12), 15), 4) - MCH60FR
YZF	1000	R1	RN12	04-06	MCF168RAC	Typ 4	System 4	13)
YZF	1000	R1	RN19	07-08	MCF199RAC	Typ 3	System 2	10)
YZF	1000	R1	RN22	09-	MCF162RAC	Typ 3	System 3	
YZF	1000	R1	RN32	15-	MCF161RAC	Typ 3	System 2	

- 1) Bremszylinder an der Rastenanlage montiert
- 2) inklusive Auspuffhalter
- 3) inklusive Halter für Hitzeblech
- 4) geänderte Bremsleitung - Art.-Nr. ... notwendig
- 5) Ritzelabdeckung entfernen
- 6) ohne Soziasraste
- 7) Schaltung durch den Rahmen
- 8) Kürzung Kolbenstange am Bremszylinder notwendig
- 9) Modifikation der Verkleidung notwendig
- 10) bei Umkehrschaltung, Ritzelabdeckung entfernen
- 11) eingeschränkter Verstellbereich
- 12) gebogene Schaltstange
- 13) Schaltung außerhalb des Rahmens
- 14) auch mit Quickshifter
- 15) nur Standard-Schaltschema möglich
- 16) nur Umkehrschaltung möglich
- 17) geänderte Verlegung der Bremsleitung notwendig
- 18) hydr. Bremslichtschalter MCF935 notwendig
- 19) nur Modelle ohne Quickshifter

Typen und Schaltungsumkehrungen
siehe Seite 5.06 - 5.07

- 1) brake cylinder mounted on the rear set
- 2) includes exhaust bracket
- 3) includes bracket for heat shield
- 4) altered brake line - art.no. ... - required
- 5) remove pinion cover
- 6) without pillion foot rest
- 7) shifting through the frame
- 8) shorter piston rod on brake cylinder required
- 9) modification of fairing required
- 10) remove pinion cover for reverse gearshift
- 11) limited adjustment range
- 12) curved gearshift rod
- 13) shifting outside the frame
- 14) also with Quickshift
- 15) only standard shifting scheme possible
- 16) only reverse gearshift possible
- 17) routing of brake line has to be changed
- 18) hydr. brake light switch MCF935 required
- 19) only models without Quickshift

Types and reverse gearshifts
see pages 5.06 - 5.07

- 1) cylindre de frein monté sur le système de repose-pieds
- 2) support pour échappement inclus
- 3) support pour tôle chauffante inclus
- 4) durite de frein modifiée - N° art. ... requis
- 5) retirer le capot du pignon
- 6) sans repose-pieds pour le passager
- 7) contact à travers le cadre
- 8) réduction de la tige de piston du cylindre de frein nécessaire
- 9) modification du revêtement requis
- 10) retirer le capot du pignon en cas de contact inversé
- 11) plage de réglage limitée
- 12) tige de sélection courbée
- 13) contact en dehors du cadre
- 14) également avec Quickshifter
- 15) schéma de couplage standard uniquement
- 16) contact inversé uniquement
- 17) pose modifiée de la durite de frein requise
- 18) contacteur hydr. pour feux stop MCF935 requis
- 19) modèles sans Quickshifter uniquement

Types et contacts inversés:
cf. pages 5.06 - 5.07

SCHALTTYPEN

TYPES DE COUPLAGES

SHIFTING TYPES

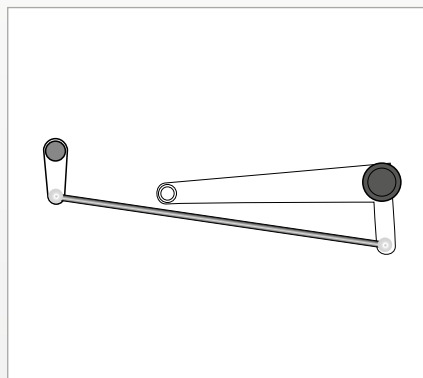

TYP 1

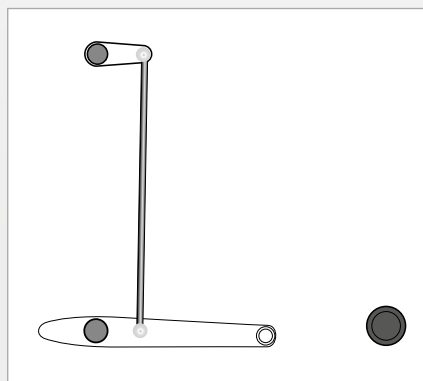

TYP 2

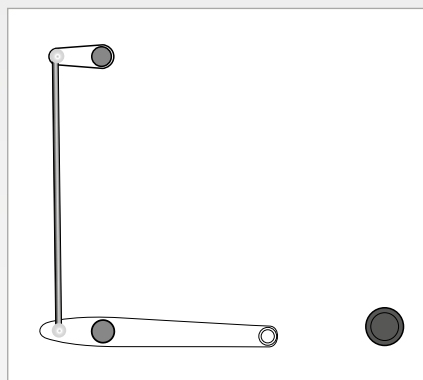

TYP 3

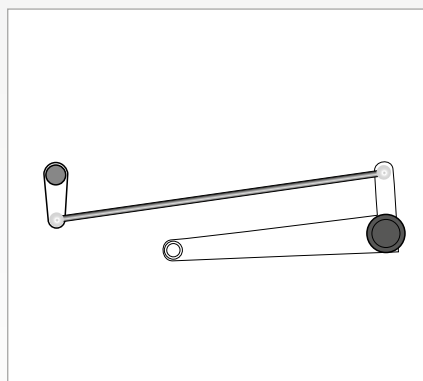

TYP 4

SCHALTUMKEHRUNGEN

COUPLAGES INVERSES
REVERSE GEARSHIFTS

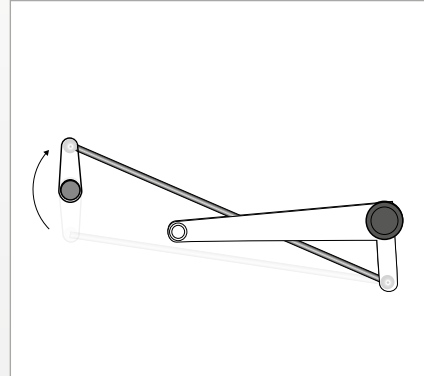

SYSTEM 1

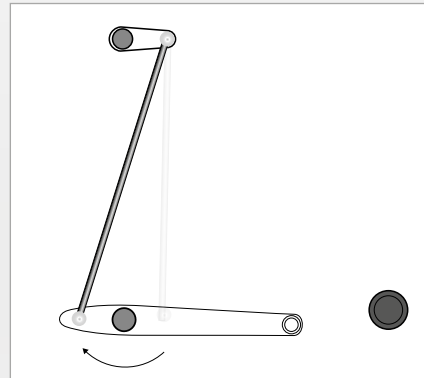

SYSTEM 2

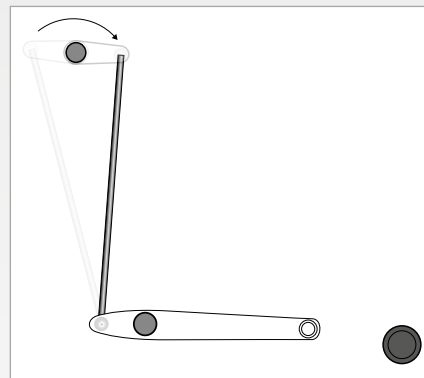

SYSTEM 3

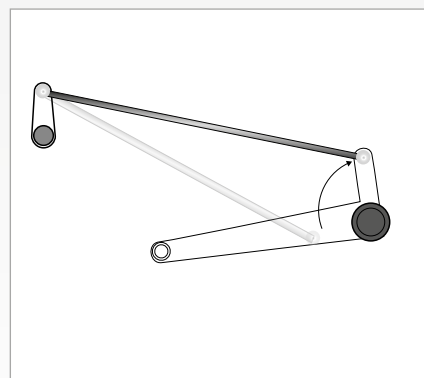

SYSTEM 4

ERATZTEILE & ZUBEHÖR

PIÈCES DE RECHANGE & ACCESSOIRES

SPARE PARTS & ACCESSORIES



Ersatzhebel, siehe Seite 5.11
Replacement lever, see page 5.11
Levier de rechange, cf. page 5.11



Bestell-Nr.
Order no.
N° comm.

MCF920 S

Ersatzteil Hebel (1 Stück)
Replacement part for lever (1 piece)
Pièce de rechange pour levier (1 pièce)



Bestell-Nr.
Order no.
N° comm.

MCF431 S

Ersatz-Schaltstangen, Außengewinde r., Innengewinde li. (Modell angeben)
Replacement shift rods, outer thread r., inner thread l. (state model)
Tige de commande sélecteur de rechange, filetage extérieur dr., filetage intérieur g. (modèle indiqué)



Ø Bohrung Ø Bore Ø Diam. trou	Gewinde Thread Filetage	Bestell-Nr. Order no. N° comm.
6 mm *	↻	MCF930
6 mm *	↺	MCF931
8 mm *	↻	MCF932
6 mm **	↻	MCF933
6 mm **	↺	MCF934

Kugelgelenkkopf
Tie rod end
Tête tournante

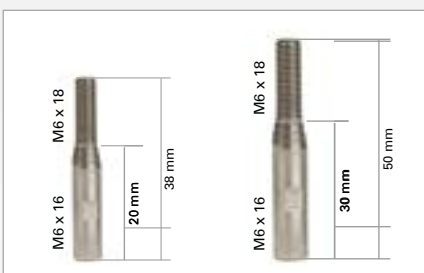



Verlängerung Extension Rallonge	Bestell-Nr. Order no. N° comm.
20 mm	MCF420
30 mm	MCF430

Schaltstangenverlängerung aus Edelstahl, Außengewinde r., Innengewinde r.
Shift rod extension, made of stainless steel, outer thread r., inner thread r.
Prolongateur de tige de commande sélecteur en acier inoxydable, filetage extérieur dr., filetage intérieur dr.



Bestell-Nr.
Order no.
N° comm.

MCF901 S 

MCF901 R 

Ersatzraste inkl. Befestigungsschraube (1 Stück)
Replacement rest incl. attachment screw (1 piece)
Repose-pied de rechange incl. vis de fixation (1 pièce)



Bestell-Nr.
Order no.
N° comm.

MCF905 S

Ersatzstopfen (2 Stück)

Replacement stoppers
(2 pieces)

Embouts de rechange
(2 pièces)



Bestell-Nr.
Order no.
N° comm.

M10x1.0

MCF935

M10x 1.25

MCF936

Hydraulischer Stopplightschalter

Hydraulic stoplight switch

Contacteur hydraulique pour feux stopw



Bestell-Nr.
Order no.
N° comm.

M10x1.0

MCF937

M10x 1.25

MCF938

Hydraulischer Stopplightschalter

Hydraulic stoplight switch

Contacteur hydraulique pour feux stopw



MCZ530

MCZ531

Bestell-Nr.
Order no.
N° comm.

gerade
straight
droit

schräg
diagonal
incliné

MCZ530

•

MCZ531

•

Bremsflüssigkeitsbehälter, Kunststoff, 15 ml

Brake fluid container, plastic

Réservoir de liquide de frein, plastique



MCZ530...

MCZ531...

Bestell-Nr.
Order no.
N° comm.

MCZ530 S



MCZ531 S



MCZ530 C



MCZ531 C



Bremsflüssigkeitsbehälter, Aluminium, 15 ml

Brake fluid container, aluminium

Réservoir de liquide de frein, aluminium



Bestell-Nr.
Order no.
N° comm.

MCF440 S



MCF440 C



**Adapter zur Verlegung von
Bremsflüssigkeitsbehältern**



Adapter for relocating brake fluid reservoirs

Adaptateur pour la pose des réservoirs de
liquide de frein

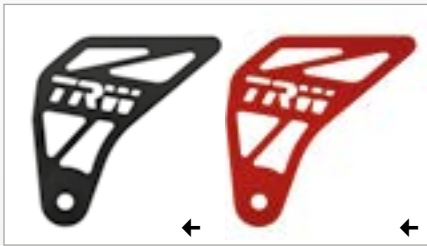
Universal Fersenschutz, links
Universal heel protection, left
Protège-talon universel, gauche



Aluminium

Bestell-Nr. Order no. N° comm.	Bestell-Nr. Order no. N° comm.
MCF927 S 	MCF927 R 



Carbon

Bestell-Nr. Order no. N° comm.
MCF928

Zusätzlicher Fersenschutz Aluminium, rechts
Additional heel protection, right
Protège-talon supplémentaire, droite



Bestell-Nr. Order no. N° comm.
MCF925 S



Ø Bohrung Ø Bore Ø Diam. trou	Bestell-Nr. Order no. N° comm.
6 mm	MCF923 S
8 mm	MCF924 S

FUSSBREMSZYLINDER

CYLINDRE DE FREIN A PIED

FOOT BRAKE CYLINDER

» Leichter, kompakter Fußbremszylinder

- » CNC-gefräst, hochfestes Aluminium
- » variable Befestigungspunkte, 37–50 mm
- » passend für alle TRW Fußrastenanlagen
- » auch für Fremdfabrikate geeignet
- » Betätigung über Kugelgelenk M8
- » Kolbendurchmesser 12,8 mm



» Lighter, more compact foot brake cylinder

- » CNC-milled, in high-strength aluminium
- » variable fixing points from 37 –50 mm
- » suitable for all TRW rear sets
- » also suitable for models from other manufacturers
- » activation by M8 ball joint
- » piston diameter 12.8 mm

» Cylindre de frein à pied plus léger et plus compact

- » fraisé par CNC, en aluminium extrêmement résistant
- » points de serrage variables de 37–50 mm
- » convient à tous les systèmes de repose-pieds
- » convient également pour les produits étrangers
- » fonctionne avec une rotule M8
- » diamètre de piston 12,8 mm



Bestell-Nr. Order no. N° comm.
MCF911 S 
MCF911 C 
MCF911 G 

MCF102RAC	MCF474S	MCF507S	MCF414-L	MCF414-R	MCF600-L	MCF600-R	MCF523	MCF431S	MCF927S	MCF923S
MCF102RAC-UM	MCF460S	MCF507S	MCF414-L	MCF414-R	MCF600-L	MCF600-R	MCF523	MCF431S	MCF927S	MCF923S
MCF103RAC	MCF465S	MCF539S	MCF448-L	MCF488-R	MCF600-L	MCF600-R	MCF534	MCF431S	MCF927S	MCF924S
MCF104RAC			MCF434-L	MCF434-R	MCF600-L	MCF600-R		MCF431S	MCF927S	MCF901S
MCF106RAC	MCF463S	MCF503S	MCF406-L	MCF406-R	MCF600-L	MCF600-R	MCF507	MCF431S	MCF927S	MCF923S
MCF107RAC	MCF463S	MCF503S	MCF407-L	MCF407-R	MCF600-L	MCF600-R	MCF507	MCF431S	MCF927S	MCF923S
MCF108RAC	MCF468S	MCF517S	MCF410-L	MCF410-R	MCF600-L	MCF600-R	MCF528	MCF431S	MCF927S	MCF923S
MCF109RAC	MCF453S	MCF553S	MCF425-L	MCF425-R	3)	3)	3)	2)	MCF927S	MCF925S
MCF110RAC	MCF463S	MCF507S	MCF426-L	MCF426-R	3)	3)	3)	MCF431S	MCF927S	MCF925S
MCF111RAC			MCF436-L	MCF436-R	MCF600-L	MCF600-R		MCF920S	MCF927S	
MCF113RAC	MCF472S	MCF506S	MCF405-L	MCF405-R	MCF600-L	MCF600-R	MCF520	2)	MCF927S	MCF924S
MCF114RAC			MCF443-L	MCF443-R	MCF600-L	MCF600-R		MCF431S	MCF927S	
MCF115RAC	MCF468S	MCF503S	MCF400-L	MCF400-R	MCF600-L	MCF600-R	MCF517	MCF431S	MCF927S	MCF924S
MCF116RAC	MCF480S	MCF502S	MCF402-L	MCF402-R	MCF600-L	MCF600-R	MCF516	MCF431S	MCF927S	MCF923S
MCF117RAC	MCF468S	MCF503S	MCF408-L	MCF408-R	MCF600-L	MCF600-R	MCF510	MCF431S	MCF927S	MCF924S
MCF118RAC	MCF461S	MCF501S	MCF401-L	MCF401-R	MCF610-L	MCF610-R	4)	MCF431S	MCF927S	MCF925S
MCF119RAC	MCF473S	MCF506S	MCF416-L	MCF416-R	MCF600-L	MCF600-R	MCF521	MCF431S	MCF927S	MCF923S
MCF125RAC	MCF473S	MCF505S	MCF437-L	MCF437-R	MCF600-L	MCF600-R	MCF509	MCF431S	MCF927S	MCF923S
MCF128RAC	MCF468S	MCF505S	MCF403-L	MCF403-R	MCF600-L	MCF600-R	MCF509	MCF431S	MCF927S	MCF923S
MCF133RAC	MCF468S	MCF507S	MCF435-L	MCF435-R	MCF600-L	MCF600-R	MCF513	MCF431S	MCF927S	
MCF145RAC	MCF468S	MCF506S	MCF419-L	MCF419-R	MCF600-L	MCF600-R	MCF536	MCF431S	MCF927S	MCF924S
MCF150RAC	MCF454S	MCF507S	MCF493-L	MCF493-R	MCF600-L	MCF600-R	MCF538	MCF431S	MCF927S	MCF923S
MCF161RAC			MCF438-L	MCF438-R	MCF600-L	MCF600-R		MCF431S	MCF927S	
MCF162RAC	MCF475S	MCF509S	MCF404-L	MCF404-R	MCF600-L	MCF600-R	MCF524	2)	MCF927S	MCF923S
MCF163RAC	MCF468S	MCF506S	MCF417-L	MCF417-R	MCF600-L	MCF600-R	MCF511	MCF431S	MCF927S	MCF923S
MCF164RAC	MCF465S	MCF505S	MCF409-L	MCF409-R	MCF600-L	MCF600-R	MCF527	MCF431S	MCF927S	MCF924S
MCF166RAC	MCF468S	MCF506S	MCF411-L	MCF411-R	MCF600-L	MCF600-R	MCF529	MCF431S	MCF927S	MCF923S
MCF168RAC	MCF465S	MCF554S	MCF424-L	MCF424-R	MCF600-L	MCF600-R	MCF537	MCF431S	MCF927S	1)
MCF169RAC	MCF471S	MCF507S	MCF482-L	MCF482-R	MCF600-L	MCF600-R	MCF519	MCF431S	MCF927S	MCF923S
MCF172RAC	MCF468S	MCF503S	MCF427-L	MCF427-R	MCF600-L	MCF600-R	MCF517	MCF431S	MCF927S	MCF924S
MCF173RAC	MCF468S	MCF535S	MCF428-L	MCF428-R	MCF600-L	MCF600-R	MCF534	MCF431S	MCF927S	1)
MCF181RAC	MCF468S	MCF506S	MCF415-L	MCF415-R	MCF600-L	MCF600-R	MCF529	MCF431S	MCF927S	MCF923S
MCF182RAC	MCF468S	MCF506S	MCF429-L	MCF429-R	MCF600-L	MCF600-R	MCF515	MCF431S	MCF927S	MCF923S
MCF183RAC	MCF468S	MCF506S	MCF481-L	MCF481-R	MCF600-L	MCF600-R	MCF515	MCF431S	MCF927S	MCF923S
MCF184RAC			MCF439-L	MCF439-R	MCF600-L	MCF600-R		MCF431S	MCF927S	
MCF186RAC	MCF466S	MCF506S	MCF483-L	MCF483-R	MCF600-L	MCF600-R	MCF515	MCF431S	MCF927S	MCF923S
MCF187RAC	MCF462S	MCF506S	MCF487-L	MCF487-R	MCF600-L	MCF600-R	MCF511	2)	MCF927S	MCF923S
MCF188RAC	MCF462S	MCF506S	MCF412-L	MCF412-R	MCF600-L	MCF600-R	MCF515	2)	MCF927S	MCF923S
MCF189RAC	MCF462S	MCF506S	MCF418-L	MCF418-R	MCF600-L	MCF600-R	MCF515	2)	MCF927S	MCF923S
MCF190RAC	MCF465S	MCF507S	MCF433-L	MCF433-R	MCF600-L	MCF600-R	MCF513	MCF431S	MCF927S	MCF924S
MCF190RAC-UM	MCF470S	MCF507S	MCF433-L	MCF433-R	MCF600-L	MCF600-R	MCF513	MCF431S	MCF927S	
MCF191RAC	MCF468S	MCF507S	MCF413-L	MCF413-R	MCF600-L	MCF600-R	MCF531	MCF431S	MCF927S	MCF923S
MCF193RAC	MCF468S	MCF535S	MCF423-L	MCF423-R	MCF600-L	MCF600-R	MCF533	MCF431S	MCF927S	1)
MCF194RAC	MCF465S	MCF505S	MCF494-L	MCF494-R	MCF600-L	MCF600-R	MCF509	MCF431S	MCF927S	MCF923S
MCF195RAC	MCF464S	MCF505S	MCF495-L	MCF495-R	MCF600-L	MCF600-R	MCF509	MCF431S	MCF927S	MCF923S
MCF196RAC	MCF466S	MCF506S	MCF496-L	MCF496-R	MCF600-L	MCF600-R	MCF515	MCF431S	MCF927S	MCF923S
MCF197RAC	MCF465S	MCF507S	MCF497-L	MCF497-R	MCF600-L	MCF600-R	MCF513	MCF431S	MCF927S	MCF924S
MCF197RAC-UM	MCF470S	MCF507S	MCF497-L	MCF497-R	MCF600-L	MCF600-R	MCF513	MCF431S	MCF927S	MCF924S
MCF198RAC	MCF468S	MCF503S	MCF498-L	MCF498-R	MCF600-L	MCF600-R	MCF510	MCF431S	MCF927S	MCF924S
MCF199RAC	MCF469S	MCF509S	MCF499-L	MCF499-R	MCF600-L	MCF600-R	MCF514	MCF431S	MCF927S	MCF924S

1) konstruktionsbedingt kein Fersenschutz montierbar
 2) Verwendung der originalen Schaltstange
 3) einteilige Konstruktion von Adapterplatte, Grundplatte und Halter für Bremszylinder
 4) Bremszylinder nicht an Fußrastenanlage montiert

1) due to the design, no heel guard can be installed
 2) use the original shifting rod
 3) one-part design of the adapter plate, baseplate and bracket for the brake cylinder
 4) brake cylinder not installed on the footrest system

1) montage de protège-talons impossible en raison de la conception
 2) utilisation de la tige de sélection d'origine
 3) conception d'une pièce de l'adaptateur, du socle et du support pour cylindre de frein
 4) cylindre de frein non monté sur le système de repose-pieds

ADAPTERPLATTEN

ADAPTATEURS

ADAPTER PLATES

» mit ABE, keine Eintragung nötig

- » Adapterplatten zur Verlegung von Original-Fußrastenanlagen
- » hochfeste Aluminiumprodukte aus CNC-Fertigung
- » variable Rastenposition für komfortable Sitzposition
- » mehr Bodenfreiheit durch geänderte Fußrastenposition
- » bei einigen Modellen empfiehlt sich der Austausch des Stopplichtsalters, siehe Seite 5.09
- » je nach Modell sind die Adapterplatten silber oder schwarz
- » bei Fahrzeugen die im OE bereits mit einer Adapterplatte ausgerüstet sind, ersetzt die TRW Adapterplatte das OE Teil und verfügt über einen größeren Verstellbereich.

» with TÜV approval

- » adapter plates for adjusting original footrest assemblies
- » highly stable CNC manufactured aluminium products
- » variable positions to make riding more comfortable
- » raises the footrest position for greater ground clearance
- » for some models, we recommend replacing the stoplight switch, see page 5.09
- » depending on the model, the adapter plates are silver or black
- » for vehicles which are already equipped with an adapter plate in the OE, the TRW adapter plate replaces the OE part offering a larger adjustment range.

» avec homologation TÜV

- » adaptateurs pour la pose de systèmes de repose-pieds d'origine
- » produits en aluminium extrêmement résistant, produit par CNC
- » position variable des repose-pieds pour une position de conduite plus agréable
- » garde au sol supérieure grâce à une position modifiée des repose-pieds
- » sur certains modèles, il est recommandé des remplacer le contacteur de feux stop, cf. page 5.09
- » selon le modèle, les plateaux d'adaptateur sont argentés ou noirs
- » pour les motos ayant déjà une platine repose pied, la platine TRW la remplace et permet une plus grande plage de réglage.



Verlegungsmöglichkeiten für Original-Fußrastenanlagen:

Makes original rear sets adjustable:

Possibilité d'ajustement avec les systèmes de repose-pieds d'origine:

→ 26 mm – 46 mm

↑ max. 25 mm

↓ max. 10 mm





**Einbaubeispiel Kawasaki ZX-10R
MCF 778-L und MCF 778-R**

*Installation example for
Kawasaki ZX-10R
MCF 778-L and MCF 778-R*

*Exemple de montage sur
Kawasaki ZX-10R
MCF 778-L et MCF 778-R*



































































**Einbaubeispiel Honda CBR900 RR
MCF 794-L und MCF 794-R**

*Installation example for
Honda CBR900RR
MCF 794-L and MCF 794-R*

*Exemple de montage sur
Honda CBR900 RR
MCF 794-L et MCF 794-R*

								Farbe Colour Couleur	
Aprilia									
RSV	1000	Mille	ME	98-00	MCF 706-L	MCF 706-R	≡≡≡		
RSV	1000	Mille	RP	01-03	MCF 706-L	MCF 706-R	≡≡≡		
RSV	1000	Mille R	RP	01-03	MCF 706-L	MCF 706-R	≡≡≡		
RSV	1000	Mille SP	RP	01-03	MCF 706-L	MCF 706-R	≡≡≡		
RSV	1000	R	RR	04-08	MCF 707-L	MCF 707-R	≡≡≡		
Honda									
CBR	600	F	PC35	99-	MCF 728-L	MCF 728-R	≡≡≡		
CBR	600	RR	PC37	03-06	MCF 794-L	MCF 794-R	≡≡≡		
CBR	600	RR	PC40	07-08	MCF 794-L	MCF 794-R	≡≡≡	2)	
CBR	600	RR	PC40	09-	MCF 794-L	MCF 794-R	≡≡≡	2)	
CBR	900	RR	SC28	92-93	MCF 721-L	MCF 721-R	≡≡≡		
CBR	900	RR	SC28	94-95	MCF 721-L	MCF 721-R	≡≡≡		
CBR	900	RR	SC33	96-97	MCF 721-L	MCF 721-R	≡≡≡		
CBR	900	RR	SC33	98-99	MCF 721-L	MCF 721-R	≡≡≡		
CBR	900	RR	SC44	00-01	MCF 791-L	MCF 791-R	≡≡≡		
CBR	954	RR	SC50	02-03	MCF 791-L	MCF 791-R	≡≡≡		
CBR	1000	RR	SC57	04-07	MCF 794-L	MCF 794-R	≡≡≡	2).	
VTR	1000	SP1	RC51	00-	MCF 792-L	MCF 792-R	≡≡≡		

							Farbe Colour Couleur	
Kawasaki								
ZX-6R	600	Ninja	ZX600F	94-97	MCF 730-L	MCF 730-R		
ZX-6R	600	Ninja	ZX600G/H	98-02	MCF 738-L	MCF 738-R		
ZX-6R	600	RR	ZX600K	03-04	MCF 777-L	MCF 777-R		
ZX-6R	600	RR	ZX600N	05-06	MCF 771-L	MCF 771-R		
ZX-6R	600	Ninja	ZX600P	07-08	MCF 795-L	MCF 795-R		
ZX-6R	600	Ninja	ZX600R	09-	MCF 795-L	MCF 795-R		2)
ZX-6R	636	Ninja	ZX636A	02	MCF 738-L	MCF 738-R		
ZX-6R	636	Ninja	ZX600B	03-04	MCF 777-L	MCF 777-R		
ZX-6R	636	Ninja	ZX600C	05-06	MCF 771-L	MCF 771-R		
ZX-7R	750	Ninja	ZX750N	96-	MCF 730-L	MCF 730-R		
ZX-7R	750	Ninja	ZX750P	96-	MCF 730-L	MCF 730-R		
Z	750		ZR750L	07-	MCF 739-L	MCF 739-R		
ZXR	750		ZX750J	91-95	MCF 730-L	MCF 730-R		
ZXR	750	R	ZX750L	91-95	MCF 730-L	MCF 730-R		
ZXR	750	R	ZX750K	91-92	MCF 730-L	MCF 730-R		
ZXR	750	R	ZX750M	93-95	MCF 730-L	MCF 730-R		
ZX-9R	900	Ninja	ZX900B	93-97	MCF 730-L	MCF 730-R		
ZX-9R	900	Ninja	ZX900C	98	MCF 738-L	MCF 738-R		
ZX-9R	900	Ninja	ZX900D	98-99	MCF 738-L	MCF 738-R		
ZX-9R	900	Ninja	ZX900E	00-03	MCF 738-L	MCF 738-R		
Z	1000		ZRT00E	07- 09	MCF 739-L	MCF 739-R		6)
ZX-10R	1000	Ninja	ZXT00C	04-05	MCF 779-L	MCF 779-R		7)
ZX-10R	1000	Ninja	ZXT00D	06 -07	MCF 778-L	MCF 778-R		
ZX-10R	1000	Ninja	ZXT00E	08-10	MCF 717-L	MCF 717-R		
Suzuki								
GSF	600	Bandit	GN77B	94-99	MCF 745-L	MCF 745-R		3)
GSF	600	Bandit	WVA8	00-04	MCF 745-L	MCF 745-R		3)
GSF	650	Bandit	WVB5	05-06	MCF 745-L	MCF 745-R		4)
GSF	650	Bandit	WVCJ	07-	MCF 746-L	MCF 746-R		
GSX-R	600		AD311	96-00	MCF 741-L	MCF 741-R		
GSX-R	600		WVBG	01-03	MCF 741-L	MCF 741-R		
GSX-R	600		WVB2	04-05	MCF 741-L	MCF 741-R		
GSX-R	600		WVCE	06-07	MCF 787-L	MCF 787-R		1)
GSX-R	600		WVCV	08-10	MCF 787-L	MCF 787-R		1)
GSX-R	600		C3	11-	MCF 708-L	MCF 708-R		1)
SV	650		AV111	99-02	MCF 741-L	MCF 741-R		3)
SV	650		WVBY	03-	MCF 741-L	MCF 741-R		
GSX-R	750	W	GR7DB	96-99	MCF 741-L	MCF 741-R		
GSX-R	750	W	WVBD	00-03	MCF 741-L	MCF 741-R		
GSX-R	750		WVB3	04-05	MCF 741-L	MCF 741-R		
GSX-R	750		WVCF	06-07	MCF 787-L	MCF 787-R		1)
GSX-R	750		WVCW	08-10	MCF 787-L	MCF 787-R		1)
GSX-R	750		C4	11-	MCF 708-L	MCF 708-R		1)
GSX-R	1000		WVBL	01-02	MCF 741-L	MCF 741-R		
GSX-R	1000		WVBZ	03-04	MCF 741-L	MCF 741-R		
GSX-R	1000		WVB6	05-06	MCF 786-L	MCF 786-R		
GSX-R	1000		WVCL	07-08	MCF 796-L	MCF 796-R		
GSX-R	1000		WVCY	09-	MCF 797-L	MCF 797-R		
SV	1000		WVBX	03-	MCF 741-L	MCF 741-R		
GSX-R	1100	W	GU75C	93-97	MCF 743-L	MCF 743-R		
GSF	1200	Bandit	GV75A	96-00	MCF 745-L	MCF 745-R		3)
GSF	1200	Bandit	WVA9	01-05	MCF 745-L	MCF 745-R		3)
GSF	1200	Bandit	WVCB	06	MCF 745-L	MCF 745-R		4)
GSF	1250	Bandit	WVCH	07-	MCF 746-L	MCF 746-R		
Triumph								
	900	Speed Triple	T509	97-99	MCF 760-L	MCF 760-R		
	950	Daytona	T595	97-98	MCF 760-L	MCF 760-R		
	955	Daytona i	T595	99-	MCF 760-L	MCF 760-R		
	955	Speed Triple	595 RPT	00-	MCF 760-L	MCF 760-R		
Yamaha								
YZF	600	R6	RJ05	03	MCF 767-L	MCF 767-R		5)
YZF	600	R6	RJ09	04-05	MCF 767-L	MCF 767-R		5)

1) vier Lochreihen

2) Hitzeblech entfällt

3) hydraulischer Stoplichtschalter MCF 935 notwendig

4) hydraulischer Stoplichtschalter MCF 936 notwendig

5) Schaltung außerhalb des Rahmens

6) Modifikation Rahmenblende notwendig

7) Eingeschränkter Verstellbereich

1) four rows of holes

2) no heat shield

3) hydraulic stoplight switch MCF 935 required

4) hydraulic stoplight switch MCF 936 required

5) shifting outside the frame

6) modification of frame panel required

7) Limited adjustment range

1) quatre rangées de trous

2) suppression de la tôle chauffante

3) contacteur hydraulique pour feux stop MCF935 requis

4) contacteur hydraulique pour feux stop MCF936 requis

5) contact en dehors du cadre

6) modification requise du panneau du cadre

7) Plage de réglages limitée



LENKER
GUIDONS
HANDLEBARS

ALUMINIUMLENKER

GUIDONS ALUMINIUM ALUMINIUM HANDLEBARS

» mit ABE, keine Eintragung nötig

- » hochwertige Aluminiumlenker mit eloxierter Oberfläche
- » hochfeste Alulegierung
- » Superbike Lenker wahlweise mit 22 mm oder 28mm Durchm. an der Klemmung
- » ideal für den Gabelbrücken-Umbau oder für Naked Bikes
- » Lenkerenden Classic sind in Form und Farbe auf die Lenker abgestimmt
- » konischer Offroad-Lenker hat eine perl-sandgestrahlte Oberfläche
- » klassischer Offroad-Lenker bevorzugt bei Reiseenduros oder Quads
- » Wandstärke Superbike und Speedfighter 5 mm, Offroad 4 mm

» with TÜV approval

- » high-quality anodised aluminium handlebars
- » high strength aluminium alloy
- » "Superbike" handlebars with a choice of a 22 mm or 28 mm diameter on the clamp
- » ideal for triple clamp conversions or for "Naked Bikes"
- » the shape and colour of the classic handlebar ends complement the handlebars
- » the conical offroad handlebars have a sandblasted surface
- » classic offroad handlebars are preferred for dual-purpose bikes and for quads
- » wall thickness Superbike and Speedfighter 5 mm, Offroad 4 mm

» avec homologation TÜV

- » guidon en aluminium haute qualité avec surface anodisée
- » alliage en aluminium à haute résistance
- » guidon supermoto avec diamètre 22 mm ou 28 mm au choix pour le serrage
- » idéal pour la transformation des fourches ou pour les «motos nues» (Naked Bikes)
- » embouts pour guidon classiques concordant avec la forme et la couleur du guidon
- » le guidon tout-terrain conique a une surface couleur sable
- » guidon tout-terrain classique préféré sur les enduros de tourisme ou les quads
- » épaisseur pour Superbike et Speedfighter: 5 mm, Offroad: 4 mm

SUPERBIKE, 22 MM











NEU: CB und SB sind perl-sandgestrahlt

NEW: CB and SB are sand blasted

NOUVEAU : CB et SB en sablage perl-sand

Bestell-Nr.
Order no.
N° comm.

MCL100 B	
MCL100 R	
MCL100 C	
MCL100 CB	
MCL100 S	
MCL100 SB	
MCL100 G	
MCL100 T	

5 mm Wandstärke
5 mm wall thickness
épaisseur 5 mm

SPEEDFIGHTER, 22 MM



Bestell-Nr. <i>Order no.</i> <i>N° comm.</i>
MCL150 C
MCL150 B
MCL150 T

5 mm Wandstärke
5 mm wall thickness
épaisseur 5 mm

SUPERBIKE KONISCH, 28 MM



Bestell-Nr. <i>Order no.</i> <i>N° comm.</i>
MCL152 C
MCL152 S

Adapter separat bestellen.
Order adapter separately.
Commander l'adaptateur séparément.

Adapter für 28-mm-Lenker zur Montage an 22-mm-Lenkeraufnahmen (2 Stück)
Adapter for 28-mm-handlebar for installation on 22-mm-handlebar clamps (2 pieces)
Adaptateur pour guidon de 28 mm pour montage sur supports de guidon de 22 mm (2 pièces)

Adapter-Set für 28-mm-Lenker (2 Stück)
Adapter set for 28-mm-handlebar (2 pieces)
Kit d'adaptation pour guidon de 28 mm (2 pièces)



Bestell-Nr. <i>Order no.</i> <i>N° comm.</i>	
MCL350 C	MCL350 S

Bestell-Nr. <i>Order no.</i> <i>N° comm.</i>	
MCL450 C	MCL450 S

Bestell-Nr. <i>Order no.</i> <i>N° comm.</i>	
MCL650 C	MCL650 S

OFFROAD, 22 MM



Auch passend für Quads
 Also suitable for quads
 Convient également pour les quads

MC Low

MC Medium

MC High

Bestell-Nr. Order no. N° comm.	Bestell-Nr. Order no. N° comm.	Bestell-Nr. Order no. N° comm.
MCL153 C 	MCL154 C 	MCL155 C 
MCL153 B 	MCL154 B 	MCL155 B 
MCL153 T 	MCL154 T 	MCL155 T 

Lenker mit Mittelstrebe in 4 mm Wandstärke

Handlebars with brace, 4 mm wall thickness

Guidon avec barre de renforcement, épaisseur 4 mm



LENKERENDEN

EMBOUTS POUR GUIDONS
HANDLEBAR ENDS



Mini MCL202 C MCL203 S MCL201 R MCL200 B MCL204 G

Classic	
Classic	
Classic	
MCL212 B	
MCL212 R	
MCL212 C	
MCL212 S	
MCL212 G	
MCL212 T	



Für MCL152... For MCL152... Pour MCL152...	
MCL214 C	
MCL214 S	

Bestell-Nr. Order no. N° comm.					A	B	C	D	E	F	Ø	Typ
MCL100 B		Superbike	MCL200 B	MCL212 B	750	53	219	110	145	91	22	0365
MCL100 R		Superbike	MCL201 R	MCL212 R	750	53	219	110	145	91	22	0365
MCL100 C		Superbike	MCL202 C	MCL212 C	750	53	219	110	145	91	22	0365
MCL100 CB		Superbike	MCL202 C	MCL212 C	750	53	219	110	145	91	22	0365
MCL100 S		Superbike	MCL203 S	MCL212 S	750	53	219	110	145	91	22	0365
MCL100 SB		Superbike	MCL203 S	MCL212 S	750	53	219	110	145	91	22	0365
MCL100 G		Superbike	MCL204 G	MCL212 G	750	53	219	110	145	91	22	0365
MCL100 T		Superbike	MCL203 S	MCL212 T	750	53	219	110	145	91	22	0365
MCL150 B		Speedfighter	MCL200 B	MCL212 B	861	47	240	79	153	67	22	0366
MCL150 C		Speedfighter	MCL202 C	MCL212 C	861	47	240	79	153	67	22	0366
MCL150 T		Speedfighter	MCL203 S	MCL212 T	861	47	240	79	153	67	22	0366
MCL152 C		Superbike		MCL214 C	795	64	205	95	178	64	28	0370
MCL152 S		Superbike		MCL214 S	795	64	205	95	178	64	28	0370
MCL153 B		Offroad low			805	42	217	65	120	68	22	0367
MCL153 C		Offroad low			805	42	217	65	120	68	22	0367
MCL153 T		Offroad low			805	42	217	65	120	68	22	0367
MCL154 B		Offroad medium			799	55	208	79	154	61	22	0368
MCL154 C		Offroad medium			799	55	208	79	154	61	22	0368
MCL154 T		Offroad medium			799	55	208	79	154	61	22	0368
MCL155 B		Offroad high			797	74	198	128	167	81	22	0369
MCL155 C		Offroad high			797	74	198	128	167	81	22	0369
MCL155 T		Offroad high			797	74	198	128	167	81	22	0369

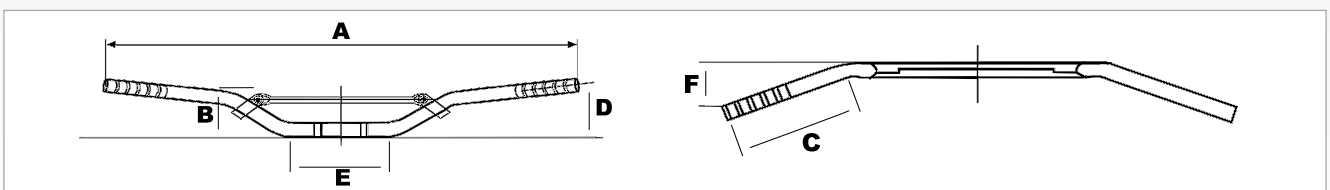

STAHLLENKER 22MM

GUIDONS ACIER

STEEL HANDLEBARS

» für viele Modelle mit ABE

- » hochwertige Stahllenkertypen
„made in Germany“
- » keine Eintragung vom TÜV notwendig
- » interessante Auswahl an Oberflächen:
Chrom, Alu-Look, schwarz
- » 3-faches Beschichtungsverfahren
verhindert Korrosion
- » die attraktive Formgebung ermöglicht
individuelle Optik
- » große Auswahl an verschiedenen
„Superbike“ Lenkertypen
- » zur Arretierung der Armatur kann
eine Bohrung angebracht werden

» with TÜV approval

- » high-quality, "made in Germany"
steel handlebar
- » TÜV registration not required
- » attractive selection of surface designs:
chrome, aluminium effect, black
- » 3-part coating procedure
prevents corrosion
- » attractive shape enables
individual optics
- » wide selection of different
"Superbike" handlebar types
- » a hole can be made to lock the fitting

» avec homologation TÜV

- » guidon acier haute qualité
« fabriqué en Allemagne »
- » aucun enregistrement auprès
de la TÜV nécessaire
- » choix intéressant de surfaces :
chromé, type alu, noir
- » revêtement triple anti-corrosion
- » la forme attractive permet une
esthétique individuelle
- » grand choix de guidons différents
de type « Superbike »
- » un alésage peut être ajouté pour
le blocage de l'armature



BESTEL LHINWEIS

CONSEILS POUR LA COMMANDE
ORDERING INSTRUCTIONS

ACHTUNG! CAUTION! ATTENTION!
Bitte die gewünschte Farbe ergänzen.
Please indicate required colour.
Veuillez indiquer la couleur souhaitée.



		
SC: Stahl, verchromt <i>steel, chrome plated</i> <i>acier avec finition chromée</i>	SA: Stahl, Alu-Look <i>steel, aluminium look</i> <i>acier avec aspect couleur aluminium</i>	SS: Stahl, schwarz <i>black steel</i> <i>acier avec aspect couleur noir</i>

SUPERBIKE, 22 MM



Speedfighter

Bestell-Nr.
Order no.
N° comm.

MCL124 SC	
MCL124 SA	
MCL124 SS	

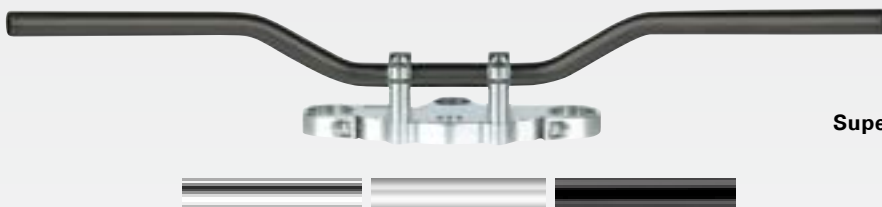

Superbike Comfort

Bestell-Nr.
Order no.
N° comm.

MCL126 SC	
MCL126 SA	
MCL126 SS	



Superbike Elegance

Bestell-Nr.
Order no.
N° comm.

MCL127 SC	
MCL127 SA	
MCL127 SS	



Superbike Sportive

Bestell-Nr.
Order no.
N° comm.

MCL128 SC	
MCL128 SA	
MCL128 SS	



TOURING, 22 MM

Bestell-Nr.
Order no.
N° comm.

MCL110 SC  **Classic High**
MCL110 SS 





Bestell-Nr.
Order no.
N° comm.

MCL111 SC  **Classic Low**
MCL111 SS 







Bestell-Nr.
Order no.
N° comm.

MCL112 SC  **Touring High**
MCL113 SC  **Touring Low**
MCL113 SS 



Bestell-Nr.
Order no.
N° comm.

MCL121 SC  **Dragbar Long**
MCL121 SS 
MCL122 SC  **Dragbar Medium**
MCL122 SS 

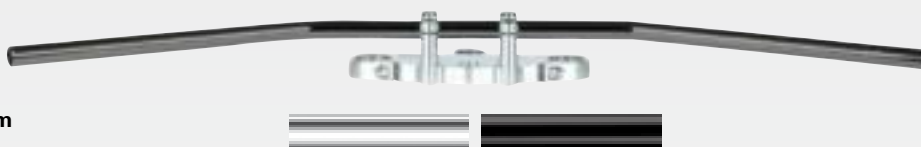

Bestell-Nr.
Order no.
N° comm.

MCL130 SC  **Mystic High**



Bestell-Nr.
Order no.
N° comm.

MCL134 SC  **Roadstar Wide**



Bestell-Nr.
Order no.
N° comm.

MCL137 SC  **Apehanger**
MCL137 SS 



CUSTOM, 22 MM

Bestell-Nr. Order no. N° comm.					A	B	C	D	E	F	Typ
MCL110	SC	SS		Classic High	810	83	240	83	130	223	01
MCL111	SC	SS		Classic Low	765	44	205	44	170	115	02
MCL112	SC			Touring High	770	126,4	220	126,4	170	224	03
MCL113	SC	SS		Touring Low	770	132	215	132	170	165	04
MCL121	SC	SS		Dragbar Long	895	0	290	0	346	149	05
MCL122	SC	SS		Dragbar Medium	800	0	240	0	336	113	06
MCL124	SC	SS	SA	Speedfighter	860	42	240	42	170	103	08
MCL126	SC	SS	SA	Superbike Comfort	720	58	200	58	140	165	09
MCL127	SC	SS	SA	Superbike Elegance	755	42	220	42	130	140	10
MCL128	SC	SS	SA	Superbike Sportive	760	31	205	31	140	94	11
MCL130	SC			Mystic High	905	130	240	130	240	191	12
MCL134	SC			Roadstar Wide	960	46	295	46	190	236	14
MCL137	SC	SS		Apehanger	830	226	190	226	180	137	16

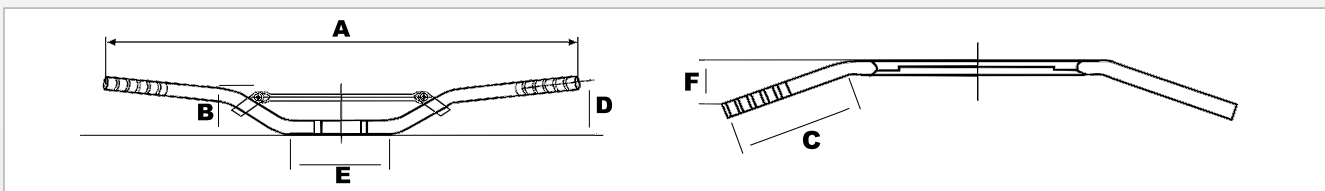

ZUBEHÖR ACCESSOIRES ACCESSORIES



Bestell-Nr. Order no. N° comm.	Lenkerenden (2 Stück) Handlebar ends (2 pieces) Embouts pour guidons (2 pièces)
MCL217 SC	
MCL217 SA	
MCL217 SS	





STAHLLENKER 1 ZOLL (25,4 MM) GUIDONS ACIER 1 POUCE STEEL HANDLEBARS 1 INCH

» mit ABE, keine Eintragung nötig

- » attraktives Design für stilgerechte Optik
- » gutes Lenkverhalten durch ausgereifte Formen
- » individuelles Outfit beginnt schon beim Lenkerumbau
- » Lenkerwechsel ermöglicht bequemere Sitzposition
- » hochwertigste Oberflächenbehandlungen
- » 3-fach-Spezialbeschichtung verhindert Korrosion
- » keine matten Chromstellen an den Biegepunkten
- » Stahlrohre von hoher Güte

» with TÜV approval

- » *attractive design adds style*
- » *good steering response through fully-developed design*
- » *customising begins with the handlebars*
- » *changing the handlebar allows a more comfortable sitting position*
- » *top quality surface treatments*
- » *triple special coating prevents corrosion*
- » *no matt chrome on the bends*
- » *high quality steel tubes*

» avec homologation TÜV

- » *design attirant et donnant du style*
- » *bon maintien du guidon grâce à des formes sophistiquées*
- » *une apparence personnalisée commence d'abord par la forme du guidon*
- » *le changement de guidon permet une position assise plus confortable*
- » *traitement de surface supérieur 3 couches spéciales anti-corrosion*
- » *pas de marques de chrome mat aux points de flexion*
- » *tubes en acier de la meilleure qualité*

3 STYLES

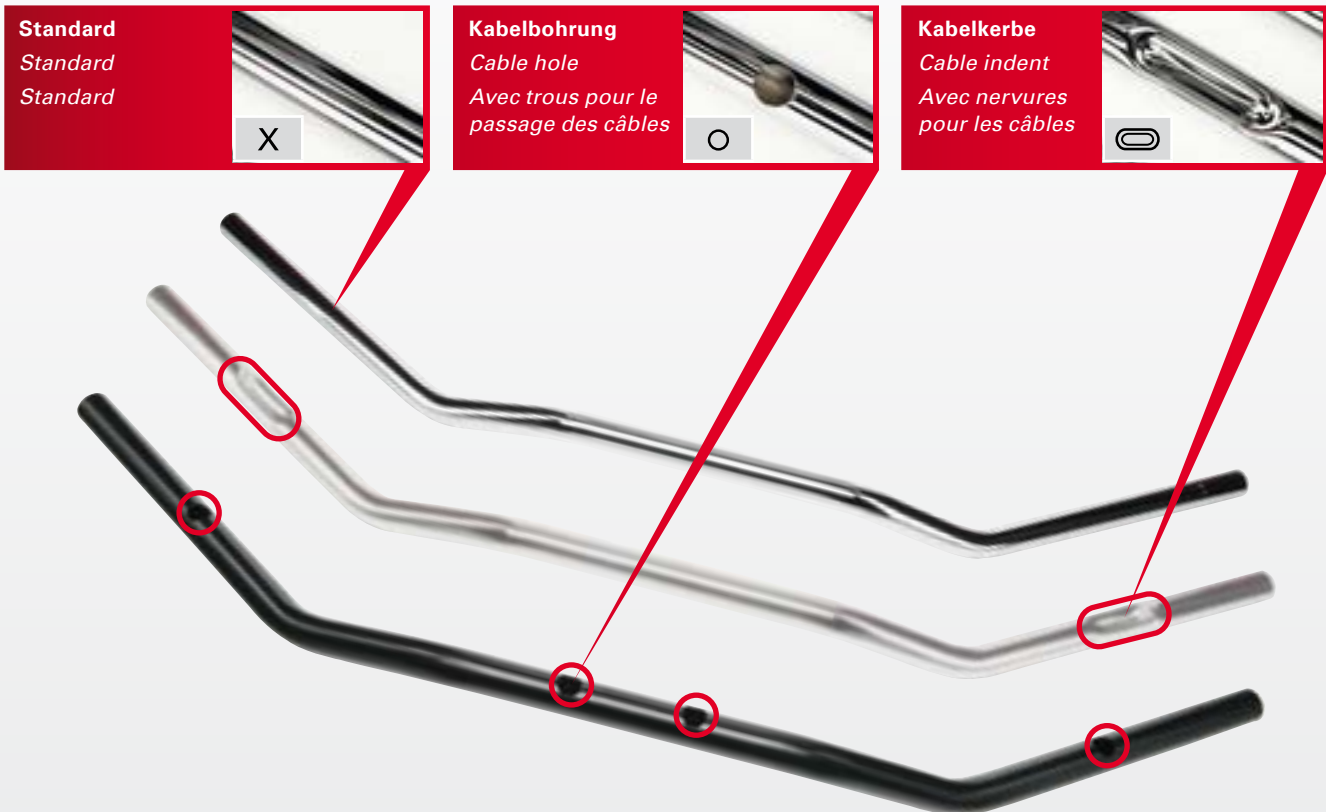

3 FARBEN 3 COULEURS
3 COLOURS

Style			
X	SC: Stahl, verchromt steel, chrome plated acier avec finition chromée	SA: Stahl, Alu-Look steel, aluminium look acier avec aspect couleur aluminium	SS: Stahl, schwarz black steel acier avec aspect couleur noir
	CKK: Stahl, verchromt mit Kabelkerben steel, chrome plated with cable indent acier avec nervures pour passage des câbles avec finition chromée	AKK: Alu-Look mit Kabelkerben aluminium look with cable indent acier avec nervures pour passage de câble et aspect couleur aluminium	SKK: schwarz mit Kabelkerben black with cable indent acier avec nervures pour passage de câble et aspect couleur noir
	CKB: Stahl, verchromt mit Kabelbohrungen steel, chrome plated with cable holes acier avec les trous pour câbles percés avec finition chromée		ACHTUNG! CAUTION! ATTENTION! Bitte gewünschte Farbe ergänzen. Please indicate required colour. Veuillez indiquer la couleur souhaitée.



Dragbar Long	MCL120 ...	X			X		
Dragbar Medium	MCL123 ...	SC	CKK	CKB	SS	SKK	



Speedfighter	MCL125 ...	X			X		
		SC	CKK		SA	AKK	
					SS	SKK	



Mystic	MCL131 ...	X			X		
		SC	CKK		SS	SKK	



Flyerbar	MCL132 ...	X			X		
		SC	CKK	CKB	SS	SKK	



Roadstar Wide	MCL133 ...	X			X		
		SC	CKK		SS	SKK	



	<input checked="" type="checkbox"/>	<input type="checkbox"/>	<input type="checkbox"/>	<input checked="" type="checkbox"/>	<input type="checkbox"/>	<input type="checkbox"/>
Roadstar Medium	X	○	○	X	○	○
MCL135 ...	SC	CKK		SS	SKK	



	<input checked="" type="checkbox"/>	<input type="checkbox"/>	<input type="checkbox"/>	<input checked="" type="checkbox"/>	<input type="checkbox"/>	<input type="checkbox"/>
Apehanger	X	○	○	X	○	○
MCL136 ...	SC	CKK		SS	SKK	

Bestell-Nr. Order no. N° comm.		Style						A	B	C	D	E	F	Typ
MCL120	Dragbar long	SC	SS		CKK	SKK	CKB	900	0	290	0	300	182	05
MCL123	Dragbar medium	SC	SS		CKK	SKK		795	0	235	0	290	132	06
MCL125	Speedfighter	SC	SS	SA	CKK	SKK	AKK	860	42	240	42	170	106	08
MCL131	Mystic	SC	SS		CKK	SKK		905	140	220	140	240	178	12
MCL132	Flyerbar	SC	SS		CKK	SKK	CKB	970	42	270	42	200	180	13
MCL133	Roadstar wide	SC	SS		CKK	SKK		965	49	290	49	190	238	14
MCL135	Roadstar medium	SC	SS		CKK	SKK		900	86	280	86	190	306	15
MCL136	Apehanger	SC	SS		CKK	SKK		920	220	235	220	170	147	16

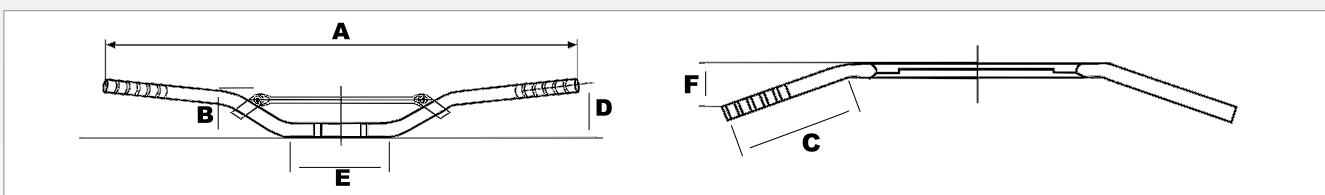

STUMMELLENKER

GUIDON BRACELET
CLIP-ONS

RACING RACING
RACING



Lieferung als Set inklusive Lenkrohr und Lenkerstopfen.

Delivery as a set, including handlebar tube and handlebar plug.

Fourni sous forme de kit avec tube de guidon et embouts.

Ø	Bestell-Nr. Order no. N° comm.
45 mm	MCL45 EC
50 mm	MCL50 EC
53 mm	MCL53 EC
55 mm	MCL55 EC

5,5° KRÖPFUNG

5.5° OFFSET

COUDAGE A 5,5°

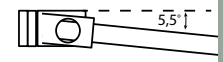

RACING – Stummel mit TÜV Gutachten

- » hightech Produkt „made in Germany“
- » hochwertiger Aluminiumlenker für den sportlichen Einsatz
- » Höhe der Klemmschelle 32 mm
- » Winkel der Lenkrohr-Kröpfung = 5,5°
- » extrem leichtgewichtig mit nur 660 g
- » schwarz eloxiert, inkl. Lenkrohre (250 mm lang) und Lenkerstopfen
- » Ausführung der Klemmschelle in 45, 50, 53 und 55 mm Durchmesser
- » Anwendung bei anderen Gabeldurchmessern mittels Distanzhülsen (siehe Seite 5.33)

RACING – clip-ons with TÜV approval

- » hightech Product „made in Germany“
- » high-grade aluminium handle bars for sportive riding
- » height of the clamp 32 mm
- » angle of the handle bar tube offset = 5.5°
- » extremely lightweight at only 660 g
- » anodised in black, incl. handlebar tubes (250 mm long) and handlebar plugs
- » 45, 50, 53 and 55 mm clamp diameter options
- » use with other fork diameters using spacer sleeves (see page 5.33)

RACING – guidon bracelet avec homologation TÜV

- » produit hightech «fabriqué en Allemagne»
- » guidon en aluminium de qualité supérieure pour le sport
- » hauteur du collier de serrage 32 mm
- » angle du coude du guidon = 5,5°
- » extrêmement léger avec seulement 660 g
- » anodisé noir, y compris les tubes (250 mm de longueur) et les embouts de guidon
- » modèles de collier de serrage en 45, 50, 53 et 55 mm de diamètre
- » utilisation pour d'autres diamètres de fourche au moyen de douilles d'écartement (voir page 5.33)

RACING-SP SP RACING

RACING-SP



NEU! NEW! NOUVEAU!

Lieferung als Set inklusive Lenkrohr und Lenkerstopfen.

Delivery as a set, including handlebar tube and handlebar plug.

Fourni sous forme de kit avec tube de guidon et embouts.

Ø	Bestell-Nr. Order no. N° comm.
45 mm	MCL45 RAC-S
50 mm	MCL50 RAC-S
53 mm	MCL53 RAC-S
55 mm	MCL55 RAC-S

5,5° KRÖPFUNG

5.5° OFFSET

COUDAGE A 5,5°

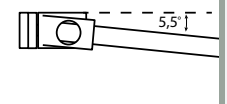

HEAVY DUTY RACING – Stummel mit TÜV Gutachten





- » High tech Produkt „made in Germany“
- » besonders stabile Konstruktion, dennoch leichter als die meisten Originallenker
- » einfacher Wechsel der Lenkrohre, zum Beispiel nach einem Sturz
- » attraktives Finish, schwarz eloxiert
- » Klemmschellendurchmesser 45, 50, 53 und 55 mm
- » Verwendung bei anderen Gabeldurchmessern mittels Distanzhülsen
- » längere Lenkrohre (285 mm) in mehreren Farben optional erhältlich







HEAVY DUTY RACING – clip-ons with TÜV certificate

- » high tech product “made in Germany”
- » particularly robust design, yet still lighter than most original handlebars
- » easy replacement of handlebar tubes, for example after a crash
- » attractive finish, black anodised
- » clamp diameter 45, 50, 53 and 55 mm
- » can be used with other fork diameters using spacer sleeves
- » longer handlebars (285 mm) optionally available in several colours

GUIDON BRACELET HEAVY DUTY – avec homologation TÜV

- » Produit haute technologie « made in Germany »
- » Construction particulièrement stable, et plus légère que la plupart des guidons d'origine
- » Changement facile des demis guidons après une chute
- » belle finition, anodisé noir
- » Diamètre des colliers de serrage : 45, 50, 53 et 55 mm
- » utilisation possible sur des fourches de diamètres différents à l'aide de douilles d'écartement
- » Demi-guidons plus longs (285 mm) disponibles optionnellement en différentes couleurs

									
Aprilia									
RSV	1000	Mille	ME	98-00	53	MCL 53 EC	MCL 53 RAC-S		
RSV	1000	Mille	RP	01-03	53	MCL 53 EC	MCL 53 RAC-S		
RSV	1000	R	RP / ME	01-03	51	MCL 53 EC	MCL 53 RAC-S		MCL 51 DH
SL	1000	Falco	PA	00-05	51	MCL 53 EC	MCL 53 RAC-S		MCL 51 DH
RSV	1000	R Factory	RR	04-10	51	MCL 53 EC	MCL 53 RAC-S		MCL 51 DH
RSV4	1000	Factory	RK	10-12	51	MCL 53 EC	MCL 53 RAC-S		MCL 51 DH
RSV4	1000	Factory APRC	RK	11-14	51	MCL 53 EC	MCL 53 RAC-S		MCL 51 DH
RSV4	1000	R	RK	10	51	MCL 53 EC	MCL 53 RAC-S		MCL 51 DH
RSV4	1000	R APRC	RK	11-	51	MCL 53 EC	MCL 53 RAC-S		MCL 51 DH
RSV4	1000	RF APRC		15-	51	MCL 53 EC	MCL 53 RAC-S		MCL 51 DH
RSV4	1000	RR		15-	51	MCL 53 EC	MCL 53 RAC-S		MCL 51 DH
BMW									
HP	1000	RR	K10	13-	55	MCL 55 EC	MCL 55 RAC-S		
	1000	RR	K10	09-	55	MCL 55 EC	MCL 55 RAC-S		
S	1000	RR	K10	09-	55	MCL 55 EC	MCL 55 RAC-S		
Ducati									
	748	S, SP, SPS	748	95-00	53	MCL 53 EC	MCL 53 RAC-S		
	748		H3	00-03	53	MCL 53 EC	MCL 53 RAC-S		
	749	R, S	H5	03-07	53	MCL 53 EC	MCL 53 RAC-S		
	750	SS	750SC	91-98	50	MCL 50 EC	MCL 50 RAC-S		
	750	SS i.E.	V2	99-02	50	MCL 50 EC	MCL 50 RAC-S		
	848	, EVO	H6	08-11	53	MCL 53 EC	MCL 53 RAC-S		
	888	Strada	888 S	93-96	50	MCL 50 EC	MCL 50 RAC-S		
	900	SS	906SC	91-98	50	MCL 50 EC	MCL 50 RAC-S		
	900	SS i.E.	V1	98-02	50	MCL 50 EC	MCL 50 RAC-S		
	916	Strada, SPO, SP	916S	94-98	53	MCL 53 EC	MCL 53 RAC-S		
	916	SPS	916S	97-98	53	MCL 53 EC	MCL 53 RAC-S		
	996	SPS	H1	97-01	53	MCL 53 EC	MCL 53 RAC-S		
	998	,S	H2	01- / 01-04	53	MCL 53 EC	MCL 53 RAC-S		
	999	,S,R,Biposto	H4	02-06	53	MCL 53 EC	MCL 53 RAC-S		
	1098	,R,S	H7	07-09	53	MCL 53 EC	MCL 53 RAC-S		
	1198	,S,SPR	H7	09-11	53	MCL 53 EC	MCL 53 RAC-S		
	1199	Panigale S	H8	12-	53	MCL 53 EC	MCL 53 RAC-S		
	1199	Panigale R	H8	13-	53	MCL 53 EC	MCL 53 RAC-S		
Honda									
CBR	600	F	PC25	91-94	41	MCL 45 EC	MCL 45 RAC-S		MCL 41 DH
CBR	600	F	PC31	95-98	41	MCL 45 EC	MCL 45 RAC-S		MCL 41 DH
CBR	600	F	PC35	99-07	43	MCL 45 EC	MCL 45 RAC-S		MCL 43 DH
CBR	600	RR	PC37	03-04	45	MCL 45 EC	MCL 45 RAC-S		
CBR	600	RR	PC37	05-06	48	MCL 50 EC	MCL 50 RAC-S		MCL 48 DH
CBR	600	RR	PC40	07-	48	MCL 50 EC	MCL 50 RAC-S		MCL 48 DH
VFR	800		RC46	98-01	41	MCL 45 EC	MCL 45 RAC-S		MCL 41 DH
VFR	800		RC46	02-05	43	MCL 45 EC	MCL 45 RAC-S		MCL 43 DH
CBR	900	RR Fireblad	SC28	92-95	45	MCL 45 EC	MCL 45 RAC-S		
CBR	900	RR Fireblad	SC33	96-97	45	MCL 45 EC	MCL 45 RAC-S		
CBR	900	RR Fireblad	SC44	00-01	50	MCL 50 EC	MCL 50 RAC-S		
CBR	900	RR Fireblad	SC50	02-03	50	MCL 50 EC	MCL 50 RAC-S		
CBR	1000	Fireblade	SC57	04-07	50	MCL 50 EC	MCL 50 RAC-S		
CBR	1000	RR Fireblad	SC59	08-	50	MCL 50 EC	MCL 50 RAC-S		
CBR	1000	RR Fireblad SP	SC59	14-	53	MCL 53 EC	MCL 53 RAC-S		
CBR	1000	F Dual	SC24	93-01	41	MCL 45 EC	MCL 45 RAC-S		MCL 41 DH
VTR	1000	Firestorm	SC36	97-08	41	MCL 45 EC	MCL 45 RAC-S		MCL 41 DH
VTR	1000	SP1	SC45	00-01	50	MCL 50 EC	MCL 50 RAC-S		
VTR	1000	SP2	SC45	02-07	50	MCL 50 EC	MCL 50 RAC-S		
CBR	1100	XX Blackbird	SC35	97-08	43	MCL 45 EC	MCL 45 RAC-S		MCL 43 DH
Kawasaki									
ZXR	400		ZX400L	91-03	50	MCL 50 EC	MCL 50 RAC-S		
ZX-6R	600	Ninja	ZX600F	94-97	41	MCL 45 EC	MCL 45 RAC-S		MCL 41 DH
ZX-6R	600	Ninja	ZX600G	98-99	46	MCL 50 EC	MCL 50 RAC-S		MCL 46 DH
ZX-6R	600	Ninja	ZX600J	00-02	46	MCL 50 EC	MCL 50 RAC-S		MCL 46 DH
ZX-6RR	600	Ninja	ZX600K	03-04	50	MCL 50 EC	MCL 50 RAC-S		
ZX-6RR	600	Ninja	ZX600N	05-06	50	MCL 50 EC	MCL 50 RAC-S		
ZX-6R	600	Ninja	ZX600P	07-08	50	MCL 50 EC	MCL 50 RAC-S		
ZX-6R	600	Ninja	ZX600R	09-	51	MCL 53 EC	MCL 53 RAC-S		MCL 51 DH
ZX-6R	636	Ninja	ZX636A	02	46	MCL 50 EC	MCL 50 RAC-S		MCL 46 DH
ZX-6R	636	Ninja	ZX636B	03-04	50	MCL 50 EC	MCL 50 RAC-S		
ZX-6R	636	Ninja	ZX636C	05-06	50	MCL 50 EC	MCL 50 RAC-S		
ZX-7R	750		ZX750P	96-02	52	MCL 53 EC	MCL 53 RAC-S		MCL 52 DH
ZXR	750	Ninja	ZX750K/L/M	92-95	52	MCL 53 EC	MCL 53 RAC-S		MCL 52 DH
ZX-9R	900	Ninja	ZX900B	94-97	52	MCL 53 EC	MCL 53 RAC-S		MCL 52 DH
ZX-9R	900	Ninja	ZX900C	98-00	46	MCL 50 EC	MCL 50 RAC-S		MCL 46 DH
ZX-9R	900	Ninja	ZX900E	01-04	46	MCL 50 EC	MCL 50 RAC-S		MCL 46 DH
Z	1000		ZRT 00 A	03-06	50	MCL 50 EC	MCL 50 RAC-S		
ZX-10R	1000	Ninja	ZXT00C	04-05	50	MCL 50 EC	MCL 50 RAC-S		
ZX-10R	1000	Ninja	ZXT00D	06-07	50	MCL 50 EC	MCL 50 RAC-S		
ZX-10R	1000	Ninja	ZXT00E	08-09	50	MCL 50 EC	MCL 50 RAC-S		
ZX-10R	1000	Ninja	ZXT00F	10-11	50	MCL 50 EC	MCL 50 RAC-S		
ZX-10R	1000	Ninja	ZXT00J	10-	50	MCL 50 EC	MCL 50 RAC-S		
ZZR	1100		ZXT10D	94-01	43	MCL 45 EC	MCL 45 RAC-S		MCL 43 DH
ZZR	1200		ZXT20C	02-05	43	MCL 45 EC	MCL 45 RAC-S		MCL 43 DH
ZZR	1400		ZXT40A	06-07	43	MCL 45 EC	MCL 45 RAC-S		MCL 43 DH

								
ZZR	1400		ZXT40C	08-11	43	MCL 45 EC	MCL 45 RAC-S	MCL 43 DH
ZZR	1400		ZXT40E	12-	43	MCL 45 EC	MCL 45 RAC-S	MCL 43 DH
KTM								
RC	390			14-	43	MCL 45 EC	MCL 45 RAC-S	MCL 43 DH
RC8	1190	R		09-	43	MCL 45 EC	MCL 45 RAC-S	MCL 43 DH
MV Augusta								
F3	675			15	50	MCL 50 EC	MCL 50 RAC-S	
F3	800			14-	50	MCL 50 EC	MCL 50 RAC-S	
Suzuki								
RGV	250		VJ22A	91-92	50	MCL 50 EC	MCL 50 RAC-S	
GSX-R	600		AD	97-00	45	MCL 45 EC	MCL 45 RAC-S	
GSX-R	600		VVVBG	01-03	45	MCL 45 EC	MCL 45 RAC-S	
GSX-R	600		VVVB2	04-05	50	MCL 50 EC	MCL 50 RAC-S	
GSX-R	600		VVCE	06-07	50	MCL 50 EC	MCL 50 RAC-S	
GSX-R	600		VWCV	08-10	50	MCL 50 EC	MCL 50 RAC-S	
GSX-R	600		C3	11-	50	MCL 50 EC	MCL 50 RAC-S	
SV	650	S	AV111	99-02	41	MCL 45 EC	MCL 45 RAC-S	MCL 41 DH
SV	650	S	VVBY	03-09	41	MCL 45 EC	MCL 45 RAC-S	MCL 41 DH
GSX-R	750		GR7AB	90-91	50	MCL 50 EC	MCL 50 RAC-S	
GSX-R	750		GR7BB	92-95	50	MCL 50 EC	MCL 50 RAC-S	
GSX-R	750		GR7DB	96-99	50	MCL 50 EC	MCL 50 RAC-S	
GSX-R	750		VVBD	00-03	50	MCL 50 EC	MCL 50 RAC-S	
GSX-R	750		VVB3	04-05	50	MCL 50 EC	MCL 50 RAC-S	
GSX-R	750		VVCF	06-07	50	MCL 50 EC	MCL 50 RAC-S	
GSX-R	750		VWCW	08-10	50	MCL 50 EC	MCL 50 RAC-S	
GSX-R	750		C4	11-	50	MCL 50 EC	MCL 50 RAC-S	
GSX-R	750		GR7DB	97-99	50	MCL 50 EC	MCL 50 RAC-S	
RF	900	R	GT73B	94-97	43	MCL 45 EC	MCL 45 RAC-S	MCL 43 DH
GSX-R	1000		VVBL	01-02	50	MCL 50 EC	MCL 50 RAC-S	
GSX-R	1000		VVBZ	03-04	50	MCL 50 EC	MCL 50 RAC-S	
GSX-R	1000		VVB6	05-06	50	MCL 50 EC	MCL 50 RAC-S	
GSX-R	1000		VVCL	07-08	50	MCL 50 EC	MCL 50 RAC-S	
GSX-R	1000		VVVCY	09-	50	MCL 50 EC	MCL 50 RAC-S	
SV	1000	,S,N	VVBX	03-08	50	MCL 50 EC	MCL 50 RAC-S	
GSX-R	1100		GV73C	90-92	52	MCL 53 EC	MCL 53 RAC-S	MCL 52 DH
GSX-R	1100	W	GU75C	93-97	52	MCL 53 EC	MCL 53 RAC-S	MCL 52 DH
GSX-R	1100	W	GU75C	95-96	50	MCL 50 EC	MCL 50 RAC-S	
SV	1000	S	VVBX	03-08	46	MCL 50 EC	MCL 50 RAC-S	MCL 46 DH
TL	1000	S	AG111	97-01	50	MCL 50 EC	MCL 50 RAC-S	
TL	1000	R	AM321	98-02	50	MCL 50 EC	MCL 50 RAC-S	
GSX-R	1100	W	GU75C	93-97	50	MCL 50 EC	MCL 50 RAC-S	
GSX-R	1300	R Hayabusa	VVA1	05-07	50	MCL 50 EC	MCL 50 RAC-S	
GSX-R	1300	R Hayabusa	VVCK	08-12	50	MCL 50 EC	MCL 50 RAC-S	
Triumph								
	600	Daytona	806 LW	03-04	43	MCL 45 EC	MCL 45 RAC-S	MCL 43 DH
	600	Speed Four	806LB	02-05	43	MCL 45 EC	MCL 45 RAC-S	MCL 43 DH
	650	Daytona	865 LX	05	43	MCL 45 EC	MCL 45 RAC-S	MCL 43 DH
	675	Daytona	D67LC	06-12	50	MCL 50 EC	MCL 50 RAC-S	
	675	Daytona	H67	13-	50	MCL 50 EC	MCL 50 RAC-S	
	900	Speed Triple	T300B	94-96	43	MCL 45 EC	MCL 45 RAC-S	MCL 43 DH
	900	Speed Triple	T509	97-98	43	MCL 45 EC	MCL 45 RAC-S	MCL 43 DH
	900	Thrupton	986ME	04-	41	MCL 45 EC	MCL 45 RAC-S	MCL 41 DH
	955	Daytona	T595	96-01	45	MCL 45 EC	MCL 45 RAC-S	
	955	Daytona	595N	02-04	50	MCL 50 EC	MCL 50 RAC-S	
	1000	Daytona	T300	92	43	MCL 45 EC	MCL 45 RAC-S	MCL 43 DH
	1200	Daytona	T300,D	93-97	43	MCL 45 EC	MCL 45 RAC-S	MCL 43 DH
Yamaha								
FZR	600		3HE	89-93	41	MCL 45 EC	MCL 45 RAC-S	MCL 41 DH
FZR	600		3RG	89-93	41	MCL 45 EC	MCL 45 RAC-S	MCL 41 DH
FZR	600		3RH	89-93	41	MCL 45 EC	MCL 45 RAC-S	MCL 41 DH
FZR	600	R	4JH	94-95	41	MCL 45 EC	MCL 45 RAC-S	MCL 41 DH
FZR	600	R	4MH	94-95	41	MCL 45 EC	MCL 45 RAC-S	MCL 41 DH
YZF	600	Thunder Cat	4TV,4WD	96-02	41	MCL 45 EC	MCL 45 RAC-S	MCL 41 DH
YZF	600	R6	RJ03	99-02	43	MCL 45 EC	MCL 45 RAC-S	MCL 43 DH
YZF	600	R6	RJ05	03	43	MCL 45 EC	MCL 45 RAC-S	MCL 43 DH
YZF	600	R6	RJ09	04-05	50	MCL 50 EC	MCL 50 RAC-S	
YZF	600	R6	RJ11	06	50	MCL 50 EC	MCL 50 RAC-S	
YZF	600	R6	RJ15	08-	50	MCL 50 EC	MCL 50 RAC-S	
YZF	750	R	4HN	93-96	50	MCL 50 EC	MCL 50 RAC-S	
YZF	750	SP	4HT	93-98	50	MCL 50 EC	MCL 50 RAC-S	
TRX	850		4UN	96-99	41	MCL 45 EC	MCL 45 RAC-S	MCL 41 DH
FZR	1000	ex up	3LE	89-90	43	MCL 45 EC	MCL 45 RAC-S	MCL 43 DH
FZR	1000	up side d.	3LE	91-95	50	MCL 50 EC	MCL 50 RAC-S	
YZF	1000	Thunder Ace	4VD	96-02	48	MCL 50 EC	MCL 50 RAC-S	MCL 48 DH
YZF	1000	R1	RN01	98-00	50	MCL 50 EC	MCL 50 RAC-S	
YZF	1000	R1	RN04	01	50	MCL 50 EC	MCL 50 RAC-S	
YZF	1000	R1	RN09	02-03	50	MCL 50 EC	MCL 50 RAC-S	
YZF	1000	R1,SP	RN12	04-06	50	MCL 50 EC	MCL 50 RAC-S	
YZF	1000	R1	RN19	07-08	50	MCL 50 EC	MCL 50 RAC-S	
YZF	1000	R1	RN22	09-	50	MCL 50 EC	MCL 50 RAC-S	
YZF	1000	R1	RN32	15-	50	MCL 50 EC	MCL 50 RAC-S	
FJ	1200	A	3YA	91-95	41	MCL 45 EC	MCL 45 RAC-S	MCL 41 DH

KOMPLETT-KITS IN 3 HÖHEN

KITS COMPLETS EN 3 HAUTEURS

COMPLETE KITS IN 3 HEIGHTS



RELAX 60

60 MM ERHÖHUNG
60 MM RISE
60 MM AUGMENTATION

4° KRÖPFUNG

4° OFFSET

COUDAGE A 4°

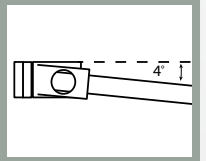

RELAX 40

40 MM ERHÖHUNG
40 MM RISE
40 MM AUGMENTATION

4° KRÖPFUNG

4° OFFSET

COUDAGE A 4°

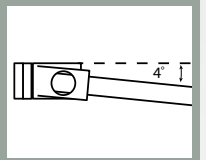

KOMFORT 20

20 MM ERHÖHUNG
20 MM RISE
20 MM AUGMENTATION

5,5° KRÖPFUNG

5.5° OFFSET

COUDAGE A 5,5°

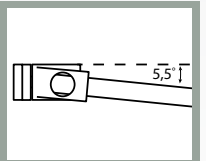

Erhöhte Lenkerstummel Kits – All in one

- » Komplettpaket inkl. Schellen, Erhöhungen und Lenkerrohre, nur Distanzhülsen und Lenkrohrstopfen müssen separat bestellt werden
- » hochwertige Ausführung aus Alu in attraktivem Design in schwarz oder silber
- » entspannte Griffhaltung entlastet die Handgelenke
- » Montage über der Gabelbrücke möglich
- » bei vielen Modellen ist die Beibehaltung des Verkleidungsoberteils möglich
- » Wechsel zum Originalzustand möglich
- » passend für viele Motorräder durch die Vielfalt der Distanzhülsen
- » Verfügbarer Klemmschellen-Durchmesser bei Komfort 20: 45 mm, 50 mm, 53 mm
- » Verfügbarer Klemmschellen-Durchmesser bei Relax 40 und 60: 45 mm und 50 mm

Raised clip-on kits – all in one

- » complete kit including clamps, risers and handlebars, only spacer sleeves and handlebar plugs have to be ordered separately
- » high quality version made of aluminium with attractive black or silver design
- » relaxed grip position takes the strain off your wrists
- » installation possible above the yoke
- » on many models the upper fairing can be retained
- » reverting back to the original state possible
- » fits a wide range of motorcycles due to different spacer sleeves
- » available clamp diameter for Comfort 20: 45 mm, 50 mm, 53 mm
- » available clamp diameter for Relax 40 and 60: 45 mm and 50 mm

Kits de guidon bracelets surélevés

- » Kit complet comprenant demi-guidons, rehausseurs et bagues de fixation, seuls les douilles d'écartement et embouts de guidon doivent être commandés séparément.
- » Modèle haut de gamme en aluminium, beau design en noir ou argent
- » une position de conduite améliorée. La pression sur les poignets est réduite
- » Montage possible sur le té de fourche
- » sur de nombreux modèles, la partie supérieure du carénage peut être conservée.
- » un retour à l'état d'origine est possible
- » convient pour de nombreuses motos grâce à la grande variété de douilles d'écartement
- » diamètres de bagues de serrage disponibles pour Komfort 20 : 45 mm, 50 mm, 53 mm
- » diamètres de bagues de serrage disponibles pour la Relax 40 et 60 : 45 mm et 50 mm

NEU! NEW! NOUVEAU!



Lieferung als Kit inklusive Schellen, Erhöhungen und Lenkrohr.
Delivery as a kit including clamps, risers and handlebar tubes.
Livré sous forme de kit, avec bagues de serrage, rehausseurs et demi guidon.



Lenkrohrstopfen aus Teflon (2 Stück)
Handlebar plugs from (2 pieces)
Embouts pour guidon, Téflon (2 pièces)

Bestell-Nr. / Order no. / N° comm.
MCL300 W <input type="checkbox"/>
MCL300 S <input type="checkbox"/>



Lenkrohrstopfen aus Alu (2 Stück)
Handlebar plugs from aluminium (2 pieces)
Embouts pour guidon, aluminium (2 pièces)





Bestell-Nr. / Order no. / N° comm.
MCL310 C <input type="checkbox"/>
MCL310 S <input type="checkbox"/>







Distanzhülsen zur Anpassung an verschiedene Gabeldurchmesser (2 Stück)
Spacers for adapting to different fork diameters (2 pieces)

Douilles d'écartement pour l'adaptation à différents diamètres de fourche (2 pièces)

Ø
38 mm
41 mm
43 mm
46 mm
48 mm
51 mm
52 mm

						I 20 mm	I 40 mm	I 60 mm	
Aprilia									
RSV	1000	Mille	ME	98-00	53	MCL 532			
RSV	1000	Mille	RP	01-03	53	MCL 532			
RSV	1000	R	RP / ME	01-03	51	MCL 532			MCL 51 DH
SL	1000	Falco	PA	00-05	51	MCL 532			MCL 51 DH
RSV	1000	R Factory	RR	04-10	51	MCL 532			MCL 51 DH
RSV4	1000	Factory	RK	10-12	51	MCL 532			MCL 51 DH
RSV4	1000	Factory APRC	RK	11-14	51	MCL 532			MCL 51 DH
RSV4	1000	R	RK	10	51	MCL 532			MCL 51 DH
RSV4	1000	R APRC	RK	11-	51	MCL 532			MCL 51 DH
RSV4	1000	RF APRC		15-	51	MCL 532			MCL 51 DH
RSV4	1000	RR		15-	51	MCL 532			MCL 51 DH
Ducati									
	748	S, SP, SPS	748	95-00	53	MCL 532			
	748		H3	00-03	53	MCL 532			
	749	R, S	H5	03-07	53	MCL 532			
	750	SS	750SC	91-98	50	MCL 502	MCL 504	MCL 506	
	750	SS i.E.	V2	99-02	50	MCL 502	MCL 504	MCL 506	
	848	, EVO	H6	08-11	53	MCL 532			
	888	Strada	888 S	93-96	50	MCL 502	MCL 504	MCL 506	
	900	SS	906SC	91-98	50	MCL 502	MCL 504	MCL 506	
	900	SS i.E.	V1	98-02	50	MCL 502	MCL 504	MCL 506	
	916	Strada, SPO, SP	916S	94-98	53	MCL 532			
	916	SPS	916S	97-98	53	MCL 532			
	996	SPS	H1	97-01	53	MCL 532			
	998	,S	H2	01- / 01-04	53	MCL 532			
	999	,S,R,Biposto	H4	02-06	53	MCL 532			
	1098	,R,S	H7	07-09	53	MCL 532			
	1198	,S,SPR	H7	09-11	53	MCL 532			
	1199	Panigale S	H8	12-	53	MCL 532			
	1199	Panigale R	H8	13-	53	MCL 532			
Honda									
CBR	600	F	PC25	91-94	41	MCL 452	MCL 454	MCL 456	MCL 41 DH
CBR	600	F	PC31	95-98	41	MCL 452	MCL 454	MCL 456	MCL 41 DH
CBR	600	F	PC35	99-07	43	MCL 452	MCL 454	MCL 456	MCL 43 DH
CBR	600	RR	PC37	03-04	45	MCL 452	MCL 454	MCL 456	
CBR	600	RR	PC37	05-06	48	MCL 452	MCL 454	MCL 456	MCL 48 DH
CBR	600	RR	PC40	07-	48	MCL 452	MCL 454	MCL 456	MCL 48 DH
VFR	800		RC46	98-01	41	MCL 452	MCL 454	MCL 456	MCL 41 DH
VFR	800		RC46	02-05	43	MCL 452	MCL 454	MCL 456	MCL 43 DH
CBR	900	RR Fireblade	SC28	92-95	45	MCL 452	MCL 454	MCL 456	
CBR	900	RR Fireblade	SC33	96-97	45	MCL 452	MCL 454	MCL 456	
CBR	900	RR Fireblade	SC44	00-01	50	MCL 502	MCL 504	MCL 506	
CBR	900	RR Fireblade	SC50	02-03	50	MCL 502	MCL 504	MCL 506	
CBR	1000	RR Fireblade	SC57	04-07	50	MCL 502	MCL 504	MCL 506	
CBR	1000	RR Fireblade	SC59	08-	50	MCL 502	MCL 504	MCL 506	
CBR	1000	RR Fireblade SP	SC59	14-	53	MCL 532			
CBR	1000	F Dual	SC24	93-01	41	MCL 452	MCL 454	MCL 456	MCL 41 DH
VTR	1000	Firestorm	SC36	97-08	41	MCL 452	MCL 454	MCL 456	MCL 41 DH
VTR	1000	SP1	SC45	00-01	50	MCL 502	MCL 504	MCL 506	
VTR	1000	SP2	SC45	02-07	50	MCL 502	MCL 504	MCL 506	
CBR	1100	XX Blackbird	SC35	97-08	43	MCL 452	MCL 454	MCL 456	MCL 43 DH
Kawasaki									
ZXR	400		ZX400L	91-03	50	MCL 502	MCL 504	MCL 506	
ZX-6R	600	Ninja	ZX600F	94-97	41	MCL 452	MCL 454	MCL 456	MCL 41 DH
ZX-6R	600	Ninja	ZX600G	98-99	46	MCL 502	MCL 504	MCL 506	MCL 46 DH
ZX-6R	600	Ninja	ZX600J	00-02	46	MCL 502	MCL 504	MCL 506	MCL 46 DH
ZX-6RR	600	Ninja	ZX600K	03-04	50	MCL 502	MCL 504	MCL 506	
ZX-6RR	600	Ninja	ZX600N	05-06	50	MCL 502	MCL 504	MCL 506	
ZX-6R	600	Ninja	ZX600P	07-08	50	MCL 502	MCL 504	MCL 506	
ZX-6R	600	Ninja	ZX600R	09-	51	MCL 532			MCL 51DH
ZX-6R	636	Ninja	ZX636A	02	46	MCL 502	MCL 504	MCL 506	MCL 46 DH
ZX-6R	636	Ninja	ZX636B	03-04	50	MCL 502	MCL 504	MCL 506	
ZX-6R	636	Ninja	ZX636C	05-06	50	MCL 502	MCL 504	MCL 506	
ZX-7R	750		ZX750P	96-02	52	MCL 532			MCL 52 DH
ZXR	750	Ninja	ZX750K/L/M	92-95	52	MCL 532			MCL 52 DH
ZX-9R	900	Ninja	ZX900B	94-97	52	MCL 532			MCL 52 DH
ZX-9R	900	Ninja	ZX900C	98-00	46	MCL 502	MCL 504	MCL 506	MCL 46 DH
ZX-9R	900	Ninja	ZX900E	01-04	46	MCL 502	MCL 504	MCL 506	MCL 46 DH
Z	1000		ZRT 00 A	03-06	50	MCL 502	MCL 504	MCL 506	
ZX-10R	1000	Ninja	ZXT00C	04-05	50	MCL 502	MCL 504	MCL 506	
ZX-10R	1000	Ninja	ZXT00D	06-07	50	MCL 502	MCL 504	MCL 506	
ZX-10R	1000	Ninja	ZXT00E	08-09	50	MCL 502	MCL 504	MCL 506	
ZX-10R	1000	Ninja	ZXT00F	10-11	50	MCL 502	MCL 504		
ZX-10R	1000	Ninja	ZXT00J	10-	50	MCL 502	MCL 504		
ZZR	1100		ZXT10D	94-01	43	MCL 452	MCL 454	MCL 456	MCL 43 DH
ZZR	1200		ZXT20C	02-05	43	MCL 452	MCL 454	MCL 456	MCL 43 DH
ZZR	1400		ZXT40A	06-07	43	MCL 452	MCL 454	MCL 456	MCL 43 DH
ZZR	1400		ZXT40C	08-11	43	MCL 452	MCL 454	MCL 456	MCL 43 DH
ZZR	1400		ZXT40E	12-	43	MCL 452	MCL 454	MCL 456	MCL 43 DH
KTM									
RC	390			14-	43	MCL 452	MCL 454	MCL 456	MCL 43 DH

						I 20 mm	I 40 mm	I 60 mm	
RC8	1190	R		09-	43	MCL 452	MCL 454	MCL 456	MCL 43 DH
MC Augusta									
F3	675			15	50	MCL 502			
F3	800			14-	50	MCL 502			
Suzuki									
RGV	250		VJ22A	91-92	50	MCL 502	MCL 504	MCL 506	
GSX-R	600		AD	97-00	45	MCL 452	MCL 454	MCL 456	
GSX-R	600		WVBG	01-03	45	MCL 452	MCL 454	MCL 456	
GSX-R	600		WVB2	04-05	50	MCL 502	MCL 504	MCL 506	
GSX-R	600		WVCE	06-07	50	MCL 502	MCL 504	MCL 506	
GSX-R	600		WVCV	08-10	50	MCL 502	MCL 504	MCL 506	
GSX-R	600		C3	11-	50	MCL 502	MCL 504	MCL 506	
SV	650	S	AV111	99-02	41	MCL 452	MCL 454	MCL 456	MCL 41 DH
SV	650	S	WVBY	03-09	41	MCL 452	MCL 454	MCL 456	MCL 41 DH
GSX-R	750		GR7AB	90-91	50	MCL 502	MCL 504	MCL 506	
GSX-R	750		GR7BB	92-95	50	MCL 502	MCL 504	MCL 506	
GSX-R	750		GR7DB	96-99	50	MCL 502	MCL 504	MCL 506	
GSX-R	750		WVBD	00-03	50	MCL 502	MCL 504	MCL 506	
GSX-R	750		WVB3	04-05	50	MCL 502	MCL 504	MCL 506	
GSX-R	750		WVCF	06-07	50	MCL 502	MCL 504	MCL 506	
GSX-R	750		WVCW	08-10	50	MCL 502	MCL 504	MCL 506	
GSX-R	750		C4	11-	50	MCL 502	MCL 504	MCL 506	
GSX-R	750		GR7DB	97-99	50	MCL 502	MCL 504	MCL 506	
RF	900	R	GT73B	94-97	43	MCL 452	MCL 454	MCL 456	MCL 43 DH
GSX-R	1000		WVBL	01-02	50	MCL 502	MCL 504	MCL 506	
GSX-R	1000		WVBZ	03-04	50	MCL 502	MCL 504	MCL 506	
GSX-R	1000		WVB6	05-06	50	MCL 502	MCL 504	MCL 506	
GSX-R	1000		WVCL	07-08	50	MCL 502	MCL 504	MCL 506	
GSX-R	1000		WVCY	09-	50	MCL 502	MCL 504	MCL 506	
SV	1000	,S,N	WVBX	03-08	50	MCL 502	MCL 504	MCL 506	
GSX-R	1100		GV73C	90-92	52	MCL 532			MCL 52 DH
GSX-R	1100	W	GU75C	93-97	52	MCL 532			MCL 52 DH
GSX-R	1100	W	GU75C	95-96	50	MCL 502	MCL 504	MCL 506	
SV	1000	S	WVBX	03-08	46	MCL 502	MCL 504	MCL 506	MCL 46 DH
TL	1000	S	AG111	97-01	50	MCL 502	MCL 504	MCL 506	
TL	1000	R	AM321	98-02	50	MCL 502	MCL 504	MCL 506	
GSX-R	1100	W	GU75C	93-97	50	MCL 502	MCL 504	MCL 506	
GSX-R	1300	R Hayabusa	WVA1	05-07	50	MCL 502	MCL 504	MCL 506	
GSX-R	1300	R Hayabusa	WVCK	08-12	50	MCL 502	MCL 504	MCL 506	
Triumph									
	600	Daytona	806 LV	03-04	43	MCL 452	MCL 454	MCL 456	MCL 43 DH
	600	Speed Four	806LB	02-05	43	MCL 452	MCL 454	MCL 456	MCL 43 DH
	650	Daytona	865 LX	05	43	MCL 452	MCL 454	MCL 456	MCL 43 DH
	675	Daytona	D67LC	06-12	50	MCL 502	MCL 504	MCL 506	
	675	Daytona	H67	13-	50	MCL 502	MCL 504	MCL 506	
	900	Speed Triple	T300B	94-96	43	MCL 452	MCL 454	MCL 456	MCL 43 DH
	900	Speed Triple	T509	97-98	43	MCL 452	MCL 454	MCL 456	MCL 43 DH
	900	Thrupton	986ME	04-	41	MCL 452	MCL 454	MCL 456	MCL 41 DH
	955	Daytona	T595	96-01	45	MCL 452	MCL 454	MCL 456	
	955	Daytona	595N	02-04	50	MCL 502	MCL 504	MCL 506	
	1000	Daytona	T300	92	43	MCL 452	MCL 454	MCL 456	MCL 43 DH
	1200	Daytona	T300,D	93-97	43	MCL 452	MCL 454	MCL 456	MCL 43 DH
Yamaha									
FZR	600		3HE	89-93	41	MCL 452	MCL 454	MCL 456	MCL 41 DH
FZR	600		3RG	89-93	41	MCL 452	MCL 454	MCL 456	MCL 41 DH
FZR	600		3RH	89-93	41	MCL 452	MCL 454	MCL 456	MCL 41 DH
FZR	600	R	4JH	94-95	41	MCL 452	MCL 454	MCL 456	MCL 41 DH
FZR	600	R	4MH	94-95	41	MCL 452	MCL 454	MCL 456	MCL 41 DH
YZF	600	Thunder Cat	4TV,4WD	96-02	41	MCL 452	MCL 454	MCL 456	MCL 41 DH
YZF	600	R6	RJ03	99-02	43	MCL 452	MCL 454	MCL 456	MCL 43 DH
YZF	600	R6	RJ05	03	43	MCL 452	MCL 454	MCL 456	MCL 43 DH
YZF	600	R6	RJ09	04-05	50	MCL 502	MCL 504	MCL 506	
YZF	600	R6	RJ11	06	50	MCL 502	MCL 504	MCL 506	
YZF	600	R6	RJ15	08-	50	MCL 502	MCL 504	MCL 506	
YZF	750	R	4HN	93-96	50	MCL 502	MCL 504	MCL 506	
YZF	750	SP	4HT	93-98	50	MCL 502	MCL 504	MCL 506	
TRX	850		4UN	96-99	41	MCL 452	MCL 454	MCL 456	MCL 41 DH
FZR	1000	ex up	3LE	89-90	43	MCL 452	MCL 454	MCL 456	MCL 43 DH
FZR	1000	up side d.	3LE	91-95	50	MCL 502	MCL 504	MCL 506	
YZF	1000	Thunder Ace	4VD	96-02	48	MCL 502	MCL 504	MCL 506	MCL 48 DH
YZF	1000	R1	RN01	98-00	50	MCL 502	MCL 504	MCL 506	
YZF	1000	R1	RN04	01	50	MCL 502	MCL 504	MCL 506	
YZF	1000	R1	RN09	02-03	50	MCL 502	MCL 504	MCL 506	
YZF	1000	R1,SP	RN12	04-06	50	MCL 502	MCL 504	MCL 506	
YZF	1000	R1	RN19	07-08	50	MCL 502	MCL 504	MCL 506	
YZF	1000	R1	RN22	09-	50	MCL 502	MCL 504	MCL 506	
YZF	1000	R1	RN32	15-	50	MCL 502	MCL 504	MCL 506	
FJ	1200	A	3YA	91-95	41	MCL 452	MCL 454	MCL 456	MCL 41 DH

Bitte gewünschte Farbe ergänzen:
 CK  Beispiel: MCL 532 CK
 SK  Beispiel: MCL 532 SK

Please indicate colour:
 CK  Example: MCL 532 CK
 SK  Example: MCL 532 SK

Veuillez ajouter pour la couleur
 CK  Example: MCL 532 CK
 SK  Example: MCL 532 SK

FÜR INDIVIDUALISTEN

POUR LA PERSONNALISATION

FOR INDIVIDUALISTS



4 FARBEN, 2 LÄNGEN
 4 COLOURS, 2 LENGTHS
 4 COULEURS, 2 LONGUEURS

3 HÖHEN, 2 FARBEN
 3 HEIGHTS, 2 COLOURS
 3 HAUTEURS, 2 COULEURS

2 MATERIALIEN, 2 FARBEN
 2 MATERIALS, 2 COLOURS
 2 MATÉRIAUX, 2 COULEURS

Für Individualisten

- » drei verschiedene Erhöhungen in schwarz oder silber
- » Lenkerrohre in vier Farben und jeweils zwei Längen
- » Lenkerrohrstopfen in zwei verschiedenen Materialien und jeweils zwei verschiedenen Farben

For individualists

- » three different risers in black or silver
- » handlebar tubes in four colours and two lengths each
- » handlebar plugs in two different materials and two different colours each

Für Individualisten

- » trois rehausseurs différents en noir ou en argent
- » Demi-guidons en 4 couleurs et 2 longueurs
- » embouts de demi-guidons en 2 matériaux différents et 2 couleurs différentes



Klemmschellen-Set (2 Stück) mit 20 mm Erhöhung.

Clamp kit (2 pieces) with 20 mm rise.

Kit de bagues de serrage (2 pièces) avec rehausseur de 20 mm.



∅ mm	Bestell-Nr. Order no. N° comm.	
45	MCL452C	MCL452S
50	MCL502C	MCL502S
53	MCL532C	MCL532S



Basis-Set mit 2 Klemmschellen (∅ 45 oder 50 mm). Bitte Aufnahme in gewünschter Höhe separat bestellen (siehe unten).

The basic set with 2 clamps (∅ 45 or 50 mm). Please order the fitting for the required height separately (see below).

Le kit de base avec 2 fixations principales (∅ 45 ou 50 mm). Veuillez commander le logement de la hauteur souhaitée séparément (voir plus bas).



∅ mm	Bestell-Nr. Order no. N° comm.	
45	MCL45C	MCL45S
50	MCL50C	MCL50S



Lenkrohraufnahme-Set in 40 oder 60 mm Höhe.

Handlebar fitting in 40 or 60 mm height.

Ensemble de supports pour guidon en 40 ou 60 mm de hauteur.



I mm	Bestell-Nr. Order no. N° comm.	
40	MCL40LAC	MCL40LAS
60	MCL60LAC	MCL60LAS

LENKERROHRE

DEMI-GUIDONS
HANDLEBAR TUBES



Eloxierte Lenkrohre mit 3 mm Wandstärke zur Verwendung mit allen TRW Stummellenkern (1 Stück)

Anodised handlebar tubes with 3 mm material thickness for use with all TRW clip-ons (1 piece).

Demi-guidons anodisé d'une épaisseur de tube de 3 mm pour une utilisation avec tous les guidons bracelet TRW (1 pièce).

mm	Bestell-Nr. Order no. N° comm.			
250	MCL250 C	MCL250 R	MCL250 S	MCL250 B
285	MCL285 C	MCL285 R	MCL285 S	MCL285 B



Lenkrohrstopfen aus Teflon (2 Stück)

Handlebar plugs from (2 pieces)

Embouts pour guidon, Téflon (2 pièces)

Bestell-Nr. / Order no. / N° comm.	
MCL300 W	
MCL300 S	



Lenkrohrstopfen aus Alu (2 Stück)

Handlebar plugs from aluminium (2 pieces)

Embouts pour guidon, aluminium (2 pièces)

Bestell-Nr. / Order no. / N° comm.	
MCL310 C	
MCL310 S	



Ø
38 mm
41 mm
43 mm
46 mm
48 mm
51 mm
52 mm

Distanzhülsen zur Anpassung an verschiedene Gabeldurchmesser (2 Stück)

Spacers for adapting to different fork diameters (2 pieces)

Douilles d'écartement pour l'adaptation à différents diamètres de fourche (2 pièces)

SPEZIELL FÜR HARLEY DAVIDSON

CONÇU SPÉCIALEMENT POUR LES HARLEY DAVIDSON

ESPECIALLY FOR HARLEY DAVIDSON



Lieferung als Set: Schellen inkl. Rohren (285 mm) mit Kabelkerbe.

Delivery as a kit: clamps including tubes (285 mm) with cable notch.

Livraison sous forme de kit : bagues de serrage et demi-guidons (285 mm) avec passage de câble.

∅	Bestell-Nr. Set Order no. Kit N° comm. kit	
35 mm	MCL35RAC-C	MCL35RAC-S
39 mm	MCL39RAC-C	MCL39RAC-S
41 mm	MCL41RAC-C	MCL41RAC-S
49 mm	MCL49RAC-C	MCL49RAC-S

RACING-Stummel für Harley Davidson

Der beste und einfachste Weg, Custom Bikes auf den Cafe Racer – Look umzubauen. Dabei überraschend komfortabel durch die moderate Geometrie mit einem Lenkrohrwinkel von 5,5 Grad.

- » Feinste, dennoch sehr robuste CNC-Frästeile aus hochfestem Aluminium
- » Aufgeräumtes Design, perfekt an ge-cleaneten Bikes
- » Lenkrohre in 25,4 mm (1 Zoll)
- » Lenkerrohr mit und ohne Kabelkerbe verfügbar
- » Klemmschellendurchmesser in 35 mm, 39 mm, 41 mm und 49 mm
- » Attraktives Finish, schwarz und silbern eloxiert

RACING clip-ons for Harley Davidson

The best and easiest way to convert custom bikes to the café racer look. Surprisingly comfortable thanks to the moderate geometry with a handlebar angle of 5.5 degrees.

- » finest yet very robust CNC milled parts made of high strength aluminium
- » clean design, perfect on cleaned bikes
- » handlebar tubes in 25.4 mm (1 inch)
- » handlebar tubes available with and without cable notch
- » clamp diameter in 35 mm, 39 mm, 41 mm and 49 mm
- » attractive finish, black and silver anodised



GUIDON BRACELET pour Harley Davidson

Le moyen le plus simple et aisé pour donner à votre moto un look « Cafe racer », tout en étant étonnamment confortables grâce à son cintrage de guidon de 5,5°.

- » Pièces en aluminium haute résistance usinées CNC d'une finition remarquable
- » beau design, parfait sur des motos épurées
- » demi-guidons de 25,4 mm (1 pouce)
- » demi-guidons disponible avec et sans passage de câble
- » diamètres des bagues de serrage : 35 mm, 39 mm, 41 mm et 49 mm
- » belle finition, anodisé noir et argent

Rohre mit Kabelkerbe
Tubes with cable notch
Demi-guidons avec passage de câble



Rohre ohne Kabelkerbe
Tubes without cable notch
Demi-guidons sans passage de câble



H mm	Bestell-Nr. Rohre Order no. Tubes N° comm. Tube	
285	MCL254CK	MCL254SK
X 285	MCL254C	MCL254S



PERFEKTE KONTROLLE

Stahl und Alulenker von TRW. Konifiziert, in Zollgrößen oder als Standardmodell.

PERFECT CONTROL

Steel and aluminium handlebars from TRW. Conified, in inch sizes or as a standard model.

UN CONTRÔLE PARFAIT

Acier et guidon alu de TRW. Conifié, tailles en pouces ou modèle standard.





BREMS- & KUPPLUNGSHEBEL
LEVIERS DE FREINS & D'EMBAYAGE
BRAKE & CLUTCH LEVERS

BREMS- UND KUPPLUNGSHEBEL, LANG

LEVIERS DE FREINS ET D'EMBRAYAGE, LONGS

BRAKE AND CLUTCH LEVERS, LONG

Brems- und Kupplungshebel „Street“ mit ABE

- » mit CNC gefräste Hebel aus Aluminium
- » ergonomisch geformte Hebel mit **80 mm Grifflänge**
- » formschöne Leichtbauweise mit perfektem Design
- » 6-fache, kugelgelagerte Verstellmöglichkeit
- » Sollbruchstelle am Hebel erhöht die Sicherheit
- » gute Dosierung und exzellentes Griffgefühl
- » schwarze und silberne Hebel mit rotem Versteller
- » goldene und blaue Hebel mit schwarzem Versteller
- » Verstellstufen leicht während der Fahrt zu betätigen
- » umfangreiches Programm

“Street“ brake and clutch levers with TÜV approval

- » CNC-milled aluminium levers
- » ergonomically shaped lever with **80 mm grip length**
- » attractively shaped, lightweight construction with a perfect design
- » 6-fold adjustment on ball-bearing mount
- » predetermined breaking point on lever increases safety
- » good application and excellent handling
- » black and silver levers with red adjuster
- » gold and blue levers with black adjuster
- » adjustment stages can be easily switched whilst riding
- » comprehensive range

Leviere de freins et d'embrayage «Street» avec homologation TÜV

- » avec élément en aluminium fraisé sur CNC
- » levier ergonomique avec **poignée de 80 mm de longueur**
- » construction légère profilée au design parfait
- » 6 positions de réglage sur roulements à billes
- » position de rupture sur le levier pour plus de sécurité
- » bon dosage et excellente sensation de prise en main
- » levier noir et argenté avec sélecteur rouge
- » levier jaune et bleu avec sélecteur noir
- » facilité de réglage durant la conduite
- » programme complet

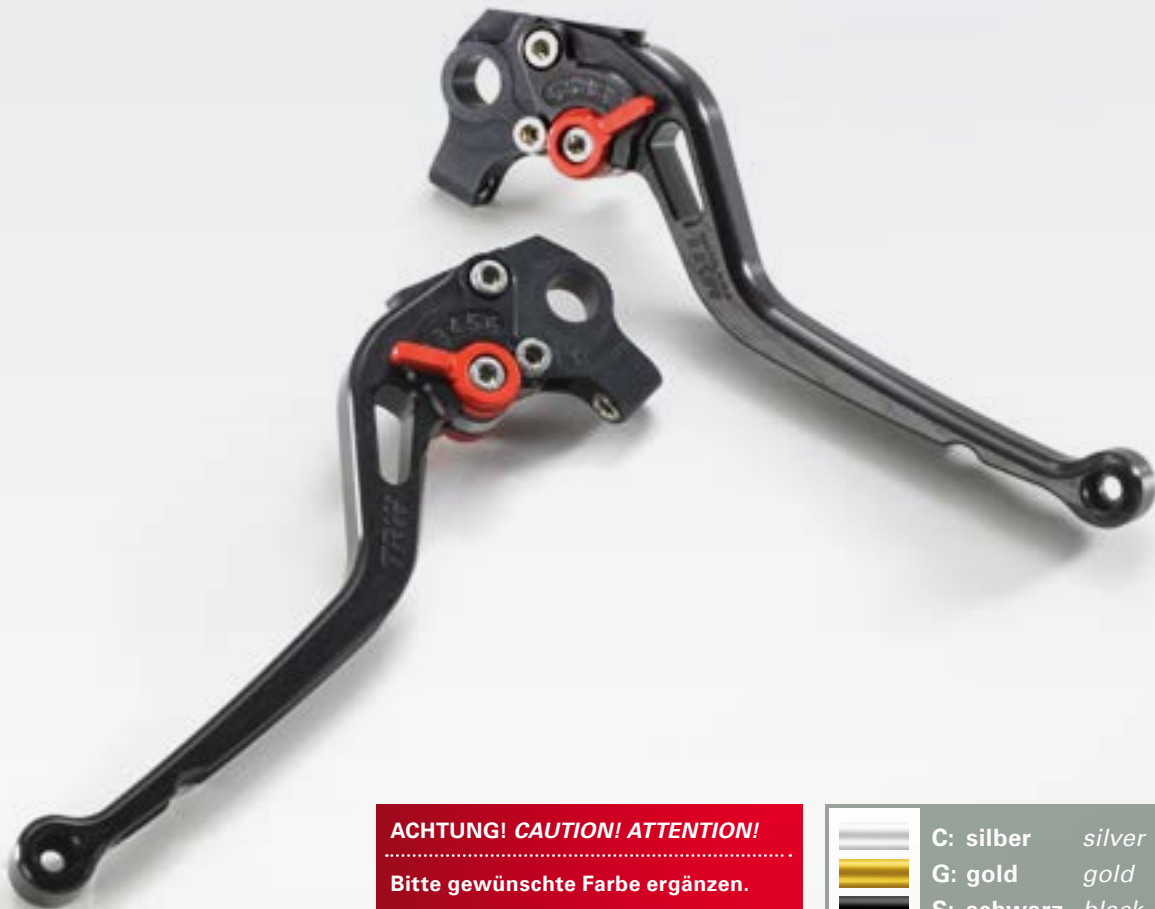





ACHTUNG! CAUTION! ATTENTION!

Bitte gewünschte Farbe ergänzen.

Please indicate required colour.

Veuillez indiquer la couleur souhaitée.

	C: silber	silver argent
	G: gold	gold or
	S: schwarz	black noir
	B: blau	blue bleu

BREMS- UND KUPPLUNGSHEBEL, KURZ

LEVIERS DE FREINS ET D'EMBRAYAGE, COURTS

BRAKE AND CLUTCH LEVERS, SHORT

Brems- und Kupplungshebel „Racing“ mit ABE

- » mit CNC gefräste Hebel aus Aluminium
- » ergonomisch geformte Hebel mit **50 mm Grifflänge**
- » formschöne Leichtbauweise mit perfektem Design
- » 6-fache, kugelgelagerte Verstellmöglichkeit
- » im internationalen Rennsport getestet
- » schwarze und silberne Hebel mit rotem Versteller
- » goldene und blaue Hebel mit schwarzem Versteller
- » exzellentes Griffgefühl für „Bremsen mit zwei Fingern“
- » umfangreiches Programm

“Racing” brake and clutch levers with TÜV approval

- » CNC-milled aluminium levers
- » ergonomically shaped lever with **50 mm grip length**
- » attractively shaped, lightweight construction with a perfect design
- » 6-fold adjustment on ball-bearing mount
- » tested in international racing
- » black and silver levers with red adjuster
- » gold and blue levers with black adjuster
- » excellent handling for 2-finger brakings
- » comprehensive range







Leviers de freins et d'embrayage « Racing » avec homologation TÜV







- » avec élément en aluminium fraisé sur CNC
- » levier ergonomique avec **poignée de 50 mm de longueur**
- » construction légère profilée au design parfait
- » 6 positions de réglage sur roulements à billes
- » test sur circuits de course internationaux
- » levier noir et argenté avec sélecteur rouge
- » levier jaune et bleu avec sélecteur noir
- » excellent prise en main pour « freiner à deux doigts »
- » programme complet















Farbe
Colour
CouleurFarbe
Colour
Couleur

Aprilia										
	750	Dorsoduro Factory ABS		10-12	MHL513	MHR513	G C S	MHL113	MHR113	G C S
ETV	1000	Caponord	PS	01-07	MHL513	MHR513	G C S	MHL113	MHR113	G C S
RSV	1000	Mille R	ME	98-00	MHL513	MHR513	G C S	MHL113	MHR113	G C S
RSV	1000	Mille R, SP	RP	01-03	MHL513	MHR513	G C S	MHL113	MHR113	G C S
RSV	1000	R, Factory	RR	04-08	MHLR525	MHRR523	G C S	MHLR125	MHRR123	G C S
	1000	Tuono	RP	02-10	MHL513	MHR513	G C S	MHL113	MHR113	G C S
	1000	Tuono R, Factory	RR	04-09	MHL513	MHR513	G C S	MHL113	MHR113	G C S
SL	1000	Falco	PA	00-05	MHL513	MHR513	G C S	MHL113	MHR113	G C S
	1200	Dorsoduro		11-12	MHL513	MHR513	G C S	MHL113	MHR113	G C S
	1200	Caponord		12-13	MHL513	MHR513	G C S	MHL113	MHR113	G C S
Bimota										
DB6	1000	Delirio		06-11	MHL513	MHR513	G C S	MHL113	MHR113	G C S
DB5	1000	S, R		06-11	MHL513	MHR513	G C S	MHL113	MHR113	G C S
DB7	1098			08-11	MHLR525	MHRR523	G C S	MHLR125	MHRR123	G C S
DB8	1198			10-11	MHLR525	MHRR523	G C S	MHLR125	MHRR123	G C S
BMW										
S	1000	RR Superbike		09-13	MHL559	MHR518	S B	MHL159	MHR118	S B
K	1200	S, R, GT		04-08	MHL537	MHR529	C S B	MHL137	MHR129	B
R	1200	R, S, ST		05-08	MHL537	MHR529	C S B	MHL137	MHR129	B
R	1200	GS, Adventure		06-08	MHL537	MHR529	C S B	MHL137	MHR129	B
	1200	HP2 Enduro		06-	MHL537	MHR529	C S B	MHL137	MHR129	B
K	1300	S, R, GT		09-	MHL537	MHR529	C S B	MHL137	MHR129	B
Buell										
XB-9R	984	Firebolt	XB1	02-08	MHL511	MHR511	G C S			
XB-9S	984	Lightning	XB1	02-08	MHL511	MHR511	G C S			
XB-1125	1125	R, RC	XB3	07-	MHL524	MHR517	G C S	MHL124	MHR117	G C S
XB-12R	1200	Firebolt	XB1	03-08	MHL511	MHR511	G C S			
XB-12S	1200	Lightning	XB2	05-08	MHL511	MHR511	G C S			
M2	1200	Cyclone	EB1	97-02	MHL511	MHR517	G C S	MHL111	MHR117	G C S
S1	1200	Lightning	EB1	97-02	MHL511	MHR517	G C S	MHL111	MHR117	G C S
X1	1200	Lightning	BL1	98-02	MHL511	MHR517	G C S	MHL111	MHR117	G C S
Ducati										
M	400	Monster	M3	98-01	MHL512	MHR512	G C S	MHL112	MHR112	G C S
M	600	Monster	M	94-98	MHL512	MHR512	G C S	MHL112	MHR112	G C S
M	600	Monster	M3	98-01	MHL512	MHR512	G C S	MHL112	MHR112	G C S
	600	SS	S	94-98	MHL512	MHR512	G C S	MHL112	MHR112	G C S
M	620	Monster i. E.	M4	01-08	MHL512	MHR512	G C S	MHL112	MHR112	G C S
	620	SS i. E.	V5	02-07	MHL513	MHR513	G C S	MHL113	MHR113	G C S
	620	Multistrada	A1	05-06	MHL513	MHR513	G C S	MHL113	MHR113	G C S
	696	Monster	M5	08-13	MHL560	MHR512	S	MHL112	MHR112	G C S
	748	S, SP	748	95-98	MHL512	MHR512	G C S	MHL112	MHR112	G C S
	748	S, SP	748	99-04	MHL513	MHR513	G C S	MHL113	MHR113	G C S
	749	, R, S	H5	02-06	MHLR525	MHRR523	G C S	MHLR125	MHRR123	G C S
	750	Monster	M	94-01	MHL512	MHR512	G C S	MHL112	MHR112	G C S
	750	Monster i. E.	M4	01-03	MHL512	MHR512	G C S	MHL112	MHR112	G C S
	750	SS	S	94-98	MHL512	MHR512	G C S	MHL112	MHR112	G C S
	796	Monster	M5	10-13	MHL560	MHR512	S			
S2R	800	Monster	M4	06-08	MHL513	MHR513	G C S	MHL113	MHR113	G C S
	848	, S	H6	09-	MHLR525	MHRR523	G C S	MHLR125	MHRR123	G C S
M	900	Monster	M	94-99	MHL512	MHR512	G C S	MHL112	MHR112	G C S
M	900	Monster i. E.	M2	99-02	MHL512	MHR512	G C S	MHL112	MHR112	G C S
M	900	Monster i. E.	M4	00-04	MHL512	MHR512	G C S	MHL112	MHR112	G C S
	900	SL, SS	S	91-98	MHL512	MHR512	G C S	MHL112	MHR112	G C S
	900	SS i. E.	V1	98-06	MHL513	MHR513	G C S	MHL113	MHR113	G C S

							Farbe Colour Couleur			Farbe Colour Couleur
M	916	Monster S4	M4	01-06	MHL513	MHR513	G C S	MHL113	MHR113	G C S
	916	Biposto	916	94-97	MHL512	MHR512	G C S	MHL112	MHR112	G C S
	916	S, SP	916	94-97	MHL512	MHR512	G C S	MHL112	MHR112	G C S
ST4	916		S2	04-06	MHL513	MHR513	G C S	MHL113	MHR113	G C S
ST2	944		S1	97-03	MHL512	MHR512	G C S	MHL112	MHR112	G C S
ST3	992		S3	03-07	MHL513	MHR513	G C S	MHL113	MHR113	G C S
S4R	996	Monster	M4	03-06	MHL513	MHR513	G C S	MHL113	MHR113	G C S
S4R	996	Monster	M4	07-	MHLR525	MHR523	G C S	MHLR125	MHR123	G C S
	996	, S, R	H2	99-03	MHL513	MHR513	G C S	MHL113	MHR113	G C S
ST4 S	996		S2	01-03	MHL513	MHR513	G C S	MHL113	MHR113	G C S
ST4 S	996		S3	03-06	MHL513	MHR513	G C S	MHL113	MHR113	G C S
	998	S, Biposto	H2	01-04	MHL513	MHR513	G C S	MHL113	MHR113	G C S
	999	, S, R	H4	02-08	MHLR525	MHR523	G C S	MHLR125	MHR123	G C S
M	1000	Monster i. E.	M4	03-08	MHL513	MHR513	G C S	MHL113	MHR113	G C S
	1000	Multistrada DS, S	A1	04-06	MHL513	MHR513	G C S	MHL113	MHR113	G C S
	1000	GT	C1	05-10	MHL513	MHR513	G C S	MHL113	MHR113	G C S
	1000	Paul Smart Replica	C1	05-08	MHL513	MHR513	G C S	MHL113	MHR113	G C S
	1000	Sport	C1	05-08	MHL513	MHR513	G C S	MHL113	MHR113	G C S
	1000	SS i. E.	V5	02-07	MHL513	MHR513	G C S	MHL113	MHR113	G C S
	1098	, R, S	H7	07-08	MHLR525	MHR523	G C S	MHLR125	MHR123	G C S
	1098	Streetfighter, S		09-11	MHLR525	MHR523	G C S	MHLR125	MHR123	G C S
	1100	DS Multistrada	A1	06-09	MHL513	MHR513	G C S	MHL113	MHR113	G C S
	1100	Monster S		09-10	MHLR525	MHR523	G C S	MHLR125	MHR123	G C S
	1100	Monster EVO		11-13	MHLR525	MHR523	G C S	MHLR125	MHR123	G C S
	1198	S, R		09-11	MHLR525	MHR523	G C S	MHLR125	MHR123	G C S
	1200	Diavel		10-	MHLR525	MHR523	G C S	MHLR125	MHR123	G C S
	1200	Multistrada		10-	MHLR525	MHR523	G C S	MHLR125	MHR123	G C S
Honda										
CB	600	Hornet	PC34	98-01	MHL514	MHR514	G C S	MHL114	MHR114	G C S
CB	600	Hornet	PC36	02-06	MHL514	MHR514	G C S	MHL114	MHR114	G C S
CBF	600		PC38	04-07	MHL514	MHR514	G C S	MHL114	MHR114	G C S
CBR	600	F	PC19	87-88	MHL514	MHR514	G C S	MHL114	MHR114	G C S
CBR	600	F	PC23	89-90	MHL514	MHR514	G C S	MHL114	MHR114	G C S
CBR	600	F	PC25	91-93	MHL514	MHR514	G C S	MHL114	MHR114	G C S
CBR	600	F	PC31	95-97	MHL514	MHR514	G C S	MHL114	MHR114	G C S
CBR	600	F	PC35	98-00	MHL514	MHR514	G C S	MHL114	MHR114	G C S
CBR	600	F	PC35	01-08	MHL514	MHR514	G C S	MHL114	MHR114	G C S
CBR	600	RR	PC37	03-06	MHL515	MHR515	G C S	MHL115	MHR115	G C S
CBR	600	RR	PC40	07-13	MHL515	MHR516	G C S	MHL115	MHR116	G C S
NT	650	Deauville	RC47	02-05	MHL514	MHR514	G C S	MHL114	MHR114	G C S
NT	700	Deauville	RC52	06-07	MHL514	MHR514	G C S	MHL114	MHR114	G C S
VFR	750	F	RC36	89-97	MHLR530	MHR514	G C S			
VFR	800	FIW	RC46	02-10	MHL516	MHR514	G C S	MHL116	MHR114	G C S
VFR	800	Cross Runner		12-13	MHL516	MHR514	G C S	MHL116	MHR114	G C S
CB	900	Hornet	SC48	01-07	MHL514	MHR514	G C S	MHL114	MHR114	G C S
CBR	900	RR	SC33	96-99	MHL514	MHR514	G C S	MHL114	MHR114	G C S
CBR	900	RR	SC44	00-01	MHL514	MHR515	G C S	MHL114	MHR115	G C S
CBR	954	RR	SC50	02-06	MHL515	MHR515	G C S	MHL115	MHR115	G C S
CBR	1000	RR	SC57	04-07	MHL516	MHR516	G C S	MHL116	MHR116	G C S
CBR	1000	RR	SC59	08-13	MHL515	MHR516	G C S	MHL115	MHR116	G C S
CBF	1000		SC58	06-09	MHLR530	MHR514	G C S			
CB	1000	R	SC60	08-13	MHL516	MHR531	S			
VTR	1000	F	SC36	97-05	MHLR530	MHR514	G C S			
VTR	1000	SP-1	SC45	00-02	MHL516	MHR515	G C S			
VTR	1000	SP-2	SC45	02-06	MHL516	MHR515	G C S			

							Farbe Colour Couleur			Farbe Colour Couleur
VFR	1200	Cross Tourer		12-	MHL516	MHR514	G C S			
CB	1300	F, S	SC54	03-13	MHL516	MHR514	G C S	MHL116	MHR114	G C S
Kawasaki										
ER-5	500		ER500D	04-05	MHL535	MHR517	G C S	MHL135	MHR117	G C S
GPZ	500			90-95	MHL535	MHR517	G C S	MHL135	MHR117	G C S
KLE	500			91-97	MHL535	MHR517	G C S	MHL135	MHR117	G C S
ER-6	600	F, N		06-08	MHL535	MHR517	G C S	MHL135	MHR117	G C S
ZZR	600		ZX600E	93-02	MHL535	MHR517	G C S	MHL135	MHR117	G C S
ZX-6R	600	Ninja	ZX600G/J	97-99	MHL535	MHR517	G C S	MHL135	MHR117	G C S
ZX-6R	600	Ninja	ZX600J	00-02	MHL517	MHR517	G C S	MHL117	MHR117	G C S
ZX-6RR	600	Ninja	ZX600K	03-06	MHL517	MHR517	G C S	MHL117	MHR117	G C S
ZX-6R	600	Ninja	ZX600P	07-13	MHL517	MHR521	G C S	MHL117	MHR121	G C S
ZX-6R	636	Ninja	ZX636A	02-04	MHL517	MHRR518	G C S	MHL117	MHR117	G C S
ZX-6R	636	Ninja	ZX636B	03-04	MHL517	MHRR518	G C S	MHL117	MHR117	G C S
ZX-6R	636	Ninja	ZX636C	05-06	MHL517	MHRR518	G C S	MHL117	MHR118	G C S
KLE	650	Versys	LE650A	06-13	MHL535	MHR517	G C S	MHL135	MHR117	G C S
Z	750		ZR750J	03-06	MHL535	MHR517	G C S	MHL135	MHR117	G C S
Z	750		ZR750L	07-13	MHL517	MHR511	G C S			
Z	750	R		11-12	MHL517	MHR521	G C S	MHL117	MHR121	G C S
ZR	750	Zephyr		91-97	MHL535	MHR517	G C S	MHL135	MHR117	G C S
ZR-7	750		ZR750F	99-04	MHL535	MHR517	G C S	MHL117	MHR117	G C S
Z	800			13-14	MHL517	MHR511	G C S			
ZX-9R	900		ZX900C	98-99	MHL535	MHR517	G C S	MHL135	MHR117	G C S
ZX-9R	900		ZX900E	00-03	MHL517	MHR517	G C S	MHL117	MHR117	G C S
Z	1000		ZRT00A	03-06	MHL517	MHR517	G C S	MHL117	MHR117	G C S
Z	1000		ZRT00B	07-12	MHL517	MHR521	G C S	MHL117	MHR121	G C S
Z	1000	SX		11-13	MHL517	MHR521	G C S	MHL117	MHR121	G C S
ZX-10R	1000	Ninja	ZXT00C	04-05	MHL517	MHR517	G C S	MHL117	MHR117	G C S
ZX-10R	1000	Ninja	ZXT00D	05-07	MHL517	MHR521	G C S	MHL117	MHR121	G C S
ZX-10R	1000	Ninja	ZXT00E	08-14	MHL517	MHR521	G C S	MHL117	MHR121	G C S
ZR	1100	Zephyr		91-97	MHL535	MHR517	G C S			
ZRX	1100		ZRT10C	96-00	MHL534	MHR517	G C S	MHL134	MHR117	G C S
ZZR	1100		ZXT10D	93-01	MHL535	MHR517	G C S	MHL135	MHR117	G C S
ZRX	1200	R, S	ZRT20A	00-07	MHL534	MHR517	G C S	MHL134	MHR117	G C S
ZX-12R	1200	Ninja	ZXT20A/B	00-06	MHL517	MHR517	G C S	MHL117	MHR117	G C S
ZZR	1200		ZXT20C	02-05	MHL534	MHR517	G C S	MHL134	MHR117	G C S
ZZR	1400		ZXT40A	06-13	MHL523	MHR521	G C S	MHL123	MHR121	G C S
VN	1500	Classic + Tourer		98-03	MHL534	MHR517	G C S	MHL134	MHR117	G C S
VN	1500	Mean Streak		02-03	MHL534	MHR517	G C S	MHL134	MHR117	G C S
VN	1600	Mean Streak		04-06	MHL534	MHR517	G C S	MHL134	MHR117	G C S
VN	1600	Classic + Tourer		03-05	MHL534	MHR517	G C S	MHL134	MHR117	G C S
KTM										
SM-R	690	Duke		08-	MHL538	MHRR523	G S	MHL138	MHRR123	G S
LC-8	990	Super Duke	KTMLC8EFI	04-08	MHL538	MHRR523	G S	MHL138	MHRR123	G S
RC-8	1190			08-13	MHL538	MHRR523	G S	MHL138	MHRR123	G S
Moto Guzzi										
	940	Bellagio		07-10	MHL513	MHR522	G C S	MHL113	MHR122	G C S
	1100	Breva	LP	05-07	MHL513	MHR522	G C S	MHL113	MHR122	G C S
	1100	/1200 Griso	LS	06-09	MHL513	MHR522	G C S	MHL113	MHR122	G C S
	1200	Breva		10-11	MHL513	MHR522	G C S	MHL113	MHR122	G C S
	1200	Norge	LS	06-13	MHL513	MHR522	G C S	MHL113	MHR122	G C S
	1200	Sport	LP	06-09	MHL513	MHR522	G C S	MHL113	MHR122	G C S
	1200	Sport 8V		09-13	MHL513	MHR522	G C S	MHL113	MHR122	G C S
	1200	Stelvio		08-13	MHL513	MHR522	G C S	MHL113	MHR122	G C S

							Farbe Colour Couleur			Farbe Colour Couleur
Moto Morini										
	1000	9,5		08-09	MHL513	MHR522	G C S	MHL113	MHR122	G C S
	1200	Granpasso		08-09	MHLR525	MHRR523	G C S	MHLR125	MHRR123	G C S
	1200	Corsaro		08-09	MHL513	MHR522	G C S	MHL113	MHR122	G C S
	1200	Scrambler		09-	MHL513	MHR522	G C S	MHL113	MHR122	G C S
	1200	Veloce		08-09	MHL513	MHR522	G C S	MHL113	MHR124	G C S
Suzuki										
GSR	600		WVB9	06-08	MHL518	MHR517	G C S	MHL118	MHR117	G C S
GSX-R	600		AD	96-00	MHL518	MHR517	G C S	MHL118	MHR117	G C S
GSX-R	600		WVBG	00-03	MHL518	MHR517	G C S	MHL118	MHR117	G C S
GSX-R	600		WVB2	04-05	MHL518	MHR518	G C S	MHL118	MHR118	G C S
GSX-R	600		WVCE	06-07	MHL519	MHRR518	B G C S	MHL119	MHRR118	B G C S
GSX-R	600		WVCV	08-12	MHL519	MHRR518	B G C S	MHL119	MHRR118	B G C S
GSF	650	Bandit	WVCJ	07-12	MHL522	MHR517	G C S	MHL122	MHR117	G C S
GSX	650	F		09-12	MHL522	MHR517	G C S	MHL122	MHR117	G C S
SV	650	Gladius		09-13	MHL518	MHR517	G C S	MHL118	MHR117	G C S
SV	650	, S	WVBY	03-08	MHLR539	MHR517	G C S			
SV	650	, S	WVBY	09-12	MHL518	MHR517	G C S	MHL118	MHR117	G C S
DL	650	V-Strom	WVB1	04-11	MHLR539	MHR517	G C S			
DL	650	V-Strom		12-13	MHL518	MHR517	G C S	MHL118	MHR117	G C S
GSR	750			11-13	MHL518	MHR517	G C S	MHL118	MHR117	G C S
GSX-R	750		GR7DB	96-99	MHL518	MHR517	G C S	MHL118	MHR117	G C S
GSX-R	750		WVBD	00-03	MHL518	MHR517	G C S	MHL118	MHR117	G C S
GSX-R	750		WFB3	04-05	MHL518	MHR518	G C S	MHL118	MHR118	G C S
GSX-R	750		WVCF	06-07	MHL519	MHRR518	B G C S	MHL119	MHRR118	B G C S
GSX-R	750		WVCW	08-12	MHL519	MHRR518	B G C S	MHL119	MHRR118	B G C S
DL	1000	V-Strom	WVBS	02-08	MHL522	MHR517	G C S	MHL122	MHR117	G C S
GSX-R	1000		WVBL	01-02	MHL518	MHR517	G C S	MHL118	MHR117	G C S
GSX-R	1000		WVBZ	03-04	MHL518	MHR517	G C S	MHL118	MHR117	G C S
GSX-R	1000		WVB6	05-06	MHL519	MHRR518	G C S	MHL119	MHRR118	G C S
GSX-R	1000		WVCL	07-08	MHLR522	MHRR518	B G C S	MHLR122	MHRR118	B G C S
GSX-R	1000		WVCY	09-13	MHL554	MHRR518	B G C S	MHL154	MHRR118	B G C S
SV	1000	, S	WVBX	03-08	MHL522	MHR517	G C S	MHL122	MHR117	G C S
GSF	1200	, S Bandit	WVA9	00-05	MHL522	MHR517	G C S	MHL122	MHR117	G C S
GSF	1200	, S Bandit	WVCB	06	MHL522	MHR517	G C S	MHL122	MHR117	G C S
GSF	1250	, S Bandit	WVCH	07-12	MHL522	MHR517	G C S	MHL122	MHR117	G C S
GSX-R	1300	Hayabusa	WVA1	98-07	MHL522	MHR517	G C S	MHL122	MHR117	G C S
GSX-R	1300	Hayabusa	WVCK	08-13	MHL522	MHR517	G C S	MHL122	MHR117	G C S
GSX	1400		WVBN	01-08	MHL522	MHR517	G C S	MHL122	MHR117	G C S
Triumph										
TT	600		806AD	00-03	MHL527	MHR517	G C S			
	600	Speed Four	H811	03-04	MHL527	MHR517	G C S			
	600	Speed Four	H811	05-06	MHL526	MHR517	G C S	MHL126	MHR117	G C S
	600	Daytona	806LW	03-05	MHL526	MHR517	G C S	MHL126	MHR117	G C S
	650	Daytona	865LX	05	MHL526	MHR517	G C S	MHL126	MHR117	G C S
	675	Daytona	D67LC	06-13	MHL526	MHRR518	G C S	MHL126	MHRR118	G C S
	675	R		11-13	MHL526	MHRR523	G C S	MHL126	MHRR123	G C S
	675	Street Triple	D67LD	07-13	MHL526	MHR517	G C S	MHL126	MHR117	G C S
	675	Street Triple R		09-13	MHL526	MHRR518	G C S	MHL126	MHRR118	G C S
	800	Scrambler		06-13	MHL526	MHR517	G C S	MHL126	MHR117	G C S
	800	Speedmaster	908ML	01-05	MHL526	MHR517	G C S	MHL126	MHR117	G C S
	865	Speedmaster	986ML	05-12	MHL526	MHR517	G C S	MHL126	MHR117	G C S
	900	Bonneville	986MK	06-13	MHL526	MHR517	G C S	MHL126	MHR117	G C S
	900	Thrupton	986ME	04-13	MHL526	MHR517	G C S	MHL126	MHR117	G C S

							Farbe Colour Couleur			Farbe Colour Couleur
955	Daytona	T595	97-00	MHL527	MHR517	G C S				
955	Daytona	595N	01-03	MHL527	MHR517	G C S				
955	Daytona i	595N	04-05	MHL526	MHR517	G C S	MHL126	MHR117	G C S	
955	Sprint RS	T695	99-01	MHL526	MHR517	G C S	MHL126	MHR117	G C S	
955	Sprint RS	695AC	02-04	MHL526	MHR517	G C S	MHL126	MHR117	G C S	
955	Sprint ST	T695	98-04	MHL527	MHR517	G C S				
955	Tiger		01-06	MHL527	MHR517	G C S				
1050	Speed Tr. Axialbremse	515NJ	04-07	MHL526	MHR517	G C S	MHL126	MHR117	G C S	
1050	Speed Tr. Radialbremse	515NJ	08-10	MHL526	MHRR518	G C S	MHL126	MHR118	G C S	
1050	Speed Tr. Radialbremse		11-13	MHL526	MHRR523	G C S	MHL126	MHRR123	G C S	
1050	Sprint ST/ABS	215NA	04-11	MHL526	MHR517	G C S	MHL126	MHR117	G C S	
1050	GT/ABS		10-13	MHL526	MHR517	G C S	MHL126	MHR117	G C S	
1050	Tiger	T709	07-13	MHL526	MHR517	G C S	MHL126	MHR117	G C S	
2300	Rocket	C23XBS3	03-08	MHL526	MHR517	G C S	MHL126	MHR117	G C S	
Yamaha										
FZS	600	Fazer	RJ02	97-03	MHL529	MHR517	G C S	MHL129	MHR117	G C S
FZ-6	600	Fazer	RJ07	04-05	MHL520	MHR522	G C S	MHL120	MHR122	G C S
FZ-6	600	Fazer	RJ14	06-10	MHL520	MHR522	G C S	MHL120	MHR122	G C S
XJ6	600	Diversion	RJ19	09-13	MHL521	MHR522	G C S	MHL120	MHR122	G C S
YZF	600	R6	RJ03	98-02	MHL520	MHR517	G C S	MHL120	MHR117	G C S
YZF	600	R6	RJ05	03	MHL520	MHR517	G C S	MHL120	MHR117	G C S
YZF	600	R6	RJ09	04-05	MHL520	MHR517	G C S	MHL120	MHRR119	G C S
YZF	600	R6	RJ11	05-07	MHL520	MHRR519	G C S	MHL120	MHRR119	G C S
YZF	600	R6	RJ15	08-13	MHL520	MHRR519	G C S	MHL120	MHRR119	G C S
FZ-8	800	, Fazer /ABS	RN25	10-13	MHL520	MHR522	G C S	MHL120	MHR122	G C S
FZS	1000	Fazer	RN06	00-03	MHL521	MHR517	G C S	MHL121	MHR117	G C S
FZS	1000	Fazer	RN14	04-05	MHL521	MHR517	G C S	MHL121	MHR117	G C S
FZ-1	1000	Fazer	RN16	06-13	MHL521	MHR522	G C S	MHL121	MHR122	G C S
YZF	1000	R1	RN04	00-01	MHL521	MHR520	G C S	MHL121	MHR120	G C S
YZF	1000	R1	RN09	02-03	MHL521	MHR520	G C S	MHL121	MHR120	G C S
YZF	1000	R1	RN12	04-06	MHL521	MHRR519	G C S	MHL121	MHRR119	G C S
YZF	1000	R1	RN19	07-08	MHL521	MHRR519	G C S	MHL121	MHRR119	G C S
YZF	1000	R1	RN22	09-13	MHL520	MHRR547	G C S	MHL120	MHRR147	G C S
VMX	1200	V-Max all modells		85-	MHL551	MHR545	S	MHL151	MHR145	S
XJR	1200		4PU	95-99	MHL524	MHR517	G C S	MHL124	MHR117	G C S
XTZ	1200	Super Tenere ABS	DP01	10-13	MHL524	MHR522	G C S	MHL124	MHR122	G C S
FJR	1300		RP04	00-02	MHL524	MHR517	G C S	MHL124	MHR117	G C S
FJR	1300		RP08	03	MHL524	MHR522	G C S	MHL124	MHR122	G C S
FJR	1300	ABS	RP11	03-05	MHL524	MHR522	G C S	MHL124	MHR122	G C S
FJR	1300	A/AS ABS	RP13	06-13	MHL524	MHR522	G C S	MHL124	MHR122	G C S
XJR	1300		RP02	98-01	MHL524	MHR517	G C S	MHL124	MHR117	G C S
XJR	1300		RP06	02-03	MHL524	MHR517	G C S	MHL124	MHR117	G C S
XJR	1300		RP10	04-05	MHL524	MHR517	G C S	MHL124	MHR117	G C S
XJR	1300		RP19	06-	MHL524	MHR522	G C S	MHL124	MHR122	G C S
MT-01	1700		RP12	04-06	MHL524	MHRR519	G C S	MHL124	MHRR119	G C S
MT-01	1700		RP18	06-13	MHL524	MHRR519	G C S	MHL124	MHRR119	G C S

ACHTUNG! CAUTION! ATTENTION!

Bitte gewünschte Farbe ergänzen.

Please indicate required colour.

Veuillez indiquer la couleur souhaitée.

	C: silber	silver argent
	G: gold	gold or
	S: schwarz	black noir
	B: blau	blue bleu



HECKHÖHER-/TIEFERLEGUNGEN

*KITS DE SURBAISSEMENT / DE SURÉLÉVATION
LOWERING / JACK UP KITS*

HECKTIEFERLEGUNGEN

KITS DE SURBAISSEMENT LOWERING KITS

» mit ABE, keine Eintragung nötig

- » ermöglicht sicheren Stand durch mehr Bodenkontakt
- » wie die Höherlegungen sind auch die Tieferlegungen aus Stahl oder Aluminium gefräst
- » durch die Absenkung muss bei den meisten Modellen der Seitenständer gekürzt werden
- » Zugstreben zur Tieferlegung sind länger als das Originalteil
- » die Tieferlegung sollte ausschließlich durch eine Fachwerkstatt durchgeführt werden

» with TÜV approval

- » allows more secure stand through greater ground contact
- » as with the jack up kits, the lowering kits are also in stainless steel or milled aluminium
- » for most models lowering means that the side stands must be shortened
- » tie rods for lowering are longer than the original part
- » the lowering should only be carried out by a specialist workshop

» avec homologation TÜV

- » permet un soutien plus sûr grâce à un meilleur contact avec le sol
- » comme les kits de surélévation, les kits de surbaissement sont fraisés dans de l'acier ou de l'aluminium
- » sur la plupart des modèles, les béquilles latérales doivent être raccourcies pour le surbaissement
- » les tirants pour kits de surbaissement sont plus longs qu les pièces d'origine
- » les kits de surbaissement ne peuvent être montés que par des ateliers spécialisés



← Vorher
before
avant

Nachher →
after
après



HECKHÖHERLEGUNGEN

JACK UP KITS KITS DE SURELEVATION

» mit ABE, keine Eintragung nötig

- » passgenaue Höherlegung des Hecks
- » besseres Handling durch geänderte Fahrwerksgeometrie
- » ermöglicht zwischen 25 mm bis 45 mm mehr Bodenfreiheit
- » mehr Last auf dem Vorderrad und bessere Optik
- » inkl. aussagefähiger Montageanleitung
- » die Höherlegung sollte ausschließlich durch eine Fachwerkstatt durchgeführt werden

» with TÜV approval

- » precise raising of the rear end
- » better handling through modified suspension geometry
- » allows between 25 to 45 mm more ground clearance
- » more load on the front wheel and improved appearance
- » including detailed assembly instructions
- » the raising should only be carried out by a specialist workshop

» avec homologation TÜV

- » surélévation correcte de l'arrière
- » meilleure manipulation grâce à une géométrie d'outil modifiée
- » permet une garde au sol de 25 à 45 mm
- » plus de poids sur la roue avant et design amélioré
- » comprenant des indications de montage explicites
- » les kits de surélévation ne peuvent être montés que par des ateliers spécialisés

TYPENÜBERSICHT

VUE D'ENSEMBLE DES TYPES

TYPES SUMERY



TYP 01



TYP 02



TYP 03



TYP 04



TYP 05

Mit Verlängerung für den Seitenständer
With stand extensions
Avec rallonge pour béquilles latérales



TYP 06

Mit abgedichteten Nadelhülsen, die über eine hohe Tragfähigkeit verfügen
With high load capacity sealed needle roller bearings
Avec douilles d'aiguille étanches, présentant une résistance accrue



TYP 07



TYP 08

Typ 01 + Typ 03 sind aus hochwertigem Stahl, lasergeschnitten; alle anderen Typen aus Aluminium, CNC-gefräst.

Type 01 + type 03 made in stainless steel, laser cut; all other models in aluminium, CNC-milled.



TYP 09



TYP 10

Type 01 et type 03 fabriqués en acier inoxydable par découpe laser; les autres modèles sont fabriqués en aluminium fraisé par CNC.



Messung der Höhenänderung lotrecht über der Hinterachse

Measuring the change in perpendicular height above the rear axle

Mesure de la modification de la hauteur verticalement au-dessus de l'essieu arrière









ACHTUNG! CAUTION! ATTENTION!









Nach der Umbaumaßnahme ist es erforderlich, dass, je nach Beladung des Fahrzeugs, das Federstoßdämpfer-Management entsprechend angepasst wird, da es sonst zu Schäden am Fahrzeug bzw. an Fahrzeugteilen kommen kann.









Following conversion and depending on the bike load, the spring shock absorber system must be modified accordingly, otherwise damage to bike or bike components may occur.

Selon les dimensions, il est nécessaire d'adapter la gestion des amortisseurs à ressort en fonction du chargement du véhicule. Sans cela, le véhicule ou des pièces de celui-ci pourraient être endommagées.

							Typ				Typ	
					+ mm				- mm			
Aprilia												
SL	750	Shiver	RA	07-10	---	---	---		MCTL161	35	10	3) 6)
SMV	750	Dorsoduro	SM	07-	---	---	---		MCTL161	25	10	3) 6)
NA	850	Mana	RC	07-10	---	---	---		MCTL162	35	10	3) 6)
RSV	1000	Mille	ME	99-	MCHL103	25	01		MCTL123	30	01	
RSV	1000	Mille	RP	00-	MCHL156	30	01		MCTL143	30	01	
RSV	1000	Mille	RR	03-	MCHL156	30	01		MCTL143	30	01	
RSV	1000	Tuono	RP	02-	MCHL156	30	01		MCTL143	30	01	
RSV	1000	R Tuono	RR	06-10	MCHL156	30	01		MCTL143	30	01	
RSV	1000	R Factory	RR	06-10	MCHL156	30	01		MCTL143	30	01	
RSV4	1000		RK	09-	MCHL156	30	01		MCTL143	20	01	
BMW												
G	450	X		08-	---	---	---		MCTL156	18	10	3)
F	650	CS Scarver	K14	02-05	---	---	---		MCTL144	25	03	
F	650	CS Scarver	E650C	03-06	---	---	---		MCTL144	25	03	
F	650		651EA	01-03	---	---	---		MCTL127	25	09	
F	650		E650G	04-07	---	---	---		MCTL127	25	09	
F	650	GS	R13	01-03	---	---	---		MCTL127	25	09	
F	650	GS	E650G	04-07	---	---	---		MCTL127	25	09	
G	650	GS	E650G	09-	---	---	---		MCTL127	25	09	
G	650	Xmoto	E65X	07-	---	---	---		MCTL161	40	10	3)
G	650	Xcountry	E65X	07-	---	---	---		MCTL161	40	10	3)
R	850	GS	BMW 259	93-	MCHL158	25	08		---	---	---	
R	850	GS	R21	01-	MCHL158	25	08		---	---	---	
R	1100	GS	BMW 259	93-	MCHL158	25	08		---	---	---	
R	1150	GS	R21	99-	MCHL158	25	08		---	---	---	
R	1150	GS Advent.	R21	01-	MCHL158	25	08		---	---	---	
K	1200	S	K12S	05-09	MCHL167	25	01		MCTL173	25	01	
K	1200	R	K12	05-09	MCHL167	25	01		MCTL173	25	01	
K	1200	R	K12R	07-08	MCHL167	25	01		MCTL173	25	01	
K	1300	S, R, GT	K12S	09-	MCHL167	25	01		MCTL173	25	01	
K	1600	GT	K16GT	12-	---	---	---		MCTL155	30	01	
Cagiva												
	650	Raptor	M2	02-	MCHL166	25	01		MCTL167	25	01	
	1000	Raptor	M2	02-	---	---	---		MCTL167	25	01	
Ducati												
	696	Monster	M5	08-	---	---	---		MCTL161	30	10	3) 6)
	796	Monster	M5	11-	---	---	---		MCTL161	30	10	3) 6)
	1100	Monster	M5	08-	---	---	---		MCTL161	30	10	3) 6)
	1100	Monster EVO	M5	11-	---	---	---		MCTL161	30	10	3) 6)
Honda												
XL	125	Varadero	JC32	01-	---	---	---		MCTL132	30	02	3)

							Typ				Typ	
					+ mm				- mm			
XR	125	L	JD19	03-	---	---	---		MCTL132	30	02	3)
CBF	500		PC39	04-	MCHL116	30	02	4)	MCTL118	30	02	4)
CBR	500	R	PC44	13-	MCHL174	25	01		MCTL183	30	01	
CB	500	F/X		13-	MCHL174	25	01		MCTL183	30	01	
CB	600	Hornet	PC34	98-99	MCHL111	35	07	4)	MCTL101	35	07	4)
CB	600	Hornet	PC34	00-01	MCHL111	35	07	4)	MCTL101	35	07	4)
CB	600	Hornet	PC36	02-06	MCHL111	35	07	4)	MCTL101	35	07	4)
CB	600	Hornet	PC41	07-08	MCHL116	30	02	4)	MCTL118	35	02	4)
CBF	600	N, S	PC38	04-	MCHL116	30	02	4)	MCTL118	35	02	4)
CBF	600	N, S	PC43	08-	MCHL116	30	02	4)	MCTL118	35	02	4)
CBR	600	F	PC25	91-	---	---	---		MCTL133	35	06	
CBR	600	F	PC31	95-98	MCHL118	30	06	5)	MCTL133	35	06	5)
CBR	600		PC35	99-00	MCHL117	30	03		MCTL100	35	03	
CBR	600		PC35	01-	MCHL117	30	03		MCTL100	35	03	
CBR	600	RR	PC40	07-	MCHL161	25	01		MCTL145	25	01	
CBR	600	RA	PC40	09-	MCHL161	25	01		MCTL145	25	01	
NTV	650	Deauville	RC47	98-05	---	---	---		MCTL118	25	02	3)
NC	700	S,SA,SD	RC61	12-	MCHL168	35	03		MCTL176	30	03	
NC	700	D	RC62	12-	MCHL168	35	03		MCTL176	30	03	
NC	700	X	RC63	12-	MCHL168	35	03		MCTL176	30	03	
NT	700	Deauville	RC52	06-	---	---	---		MCTL118	25	02	3)
NT	700	Deauville	RC59	10-	---	---	---		MCTL118	25	02	3)
NC	750	SA,SD,S	RC70	14-	MCHL168	35	03		MCTL176	30	03	
NC	750	X,XA,XD	RC72	14-	MCHL168	35	03		MCTL176	30	03	
VFR	800	ABS	RC46	02-	MCHL113	25	01		MCTL134	25	01	
VFR	800	X Crossrunner	RC60A	11-	MCHL113	25	01		MCTL134	25	01	
CBR	900	RR	SC28	92-95	MCHL100	25	01		---	---	---	
CBR	900	RR	SC33	96-99	MCHL101	35	01		---	---	---	
CBR	900	RR	SC44	00-	MCHL102	25	01		MCTL116	25	01	
CBR	900	RR	SC50	02-	MCHL103	25	01		MCTL123	25	01	
CBF	1000		SC58	06-	MCHL116	30	02	4)	---	---	---	
CBR	1000	RR, RA	SC57	04-07	MCHL115	30	06		MCTL181	35	06	
CBR	1000	RR	SC59	08-	MCHL162	30	01		MCTL147	40	01	
CBR	1000	RA	SC59	09-	MCHL162	30	01		MCTL147	40	01	
VTR	1000	F	SC36	97-	MCHL155	30	07	3)	---	---	---	
VTR	1000	F	SC36	04-	MCHL155	30	07	3)	---	---	---	
VTR	1000	SP 1	SC45	00-	MCHL157	30	07	3)	---	---	---	
VTR	1000	SP 2	SC45	02-	MCHL157	30	07	3)	---	---	---	
XL	1000	Varadero	SD01	99-03	MCHL114	30	01		MCTL135	35	01	
XL	1000	Varadero	SD02	01-	MCHL114	30	01		MCTL102	35	01	
XL	1000	Varadero	SD03	11-	MCHL114	30	01		MCTL102	35	01	
CB	1100	X-eleven	SC42	99-	MCHL116	25	02	4)	MCTL118	35	02	4)
CBR	1100	XX	SC35	01-	MCHL116	30	02	4)	MCTL117	30	01	
VFR	1200	F	SC63	10-	MCHL165	30	01		MCTL172	25	01	
VFR	1200	X	SC70	12-	MCHL171	35	01		MCTL179	30	01	
Husquvarna												
	650	Terra/Strada	A8	12-	---	---	---		MCTL156	35	10	3) 6)
	900	Nuda	HA700A	12-	---	---	---		MCTL161	35	10	3) 6)
	900	Nuda R	OH02	12-	---	---	---		MCTL162	35	10	3) 6)
Kawasaki												
ZX	250	R	EX250K	08-	MCHL105	30	03		MCTL139	25	03	
	300	Ninja	EX300A	12-	MCHL105	30	03	8)	MCTL184	25	03	8)
Z	300		ER300A	15-	MCHL143	30	03		MCTL184	25	03	
GPZ	500	S	EX500D (E)	94-	---	---	---		MCTL112	40	03	
ZX-6R	600	Ninja	ZX600F	95-	MCHL110	30	03		MCTL103	35	03	
ZX-6R	600	Ninja	ZX600G	98-99	MCHL110	30	03		MCTL124	35	03	
ZX-6R	600	Ninja	ZX600J	00-02	MCHL110	30	03		MCTL124	35	03	
ZX-6RR	600	Ninja	ZX600K	03-04	---	---	---		MCTL124	35	03	
ZX-6RR	600	Ninja	ZX600N	05-06	MCHL110	30	03		MCTL103	35	03	
ZX-6R	600	Ninja, RR	ZX600P	06-08	MCHL110	30	03		MCTL103	40	03	
ZX-6R	600	Ninja, R	ZX600R	09-12	---	---	---		MCTL119	40	03	
ZX-6R	636	Ninja	ZX636A	02-	MCHL110	30	03		MCTL124	35	03	
ZX-6R	636	Ninja	ZX636B	03-04	MCHL110	30	03		MCTL124	35	03	
ZX-6R	636	Ninja	ZX636C	04-06	MCHL110	30	03		MCTL103	35	03	
ZX-6R	636	Ninja	ZX636E	13-	MCHL110	30	03		MCTL103	35	03	
ER-6	650	N	ER650A	06-08	---	---	---		MCTL125	25	10	3) 6)
ER-6	650	F	EX650A	06-08	---	---	---		MCTL125	25	10	3) 6)
	650	Versys	LE650A (A,B)	06-	---	---	---		MCTL163	25	04	
	650	Versys	LE650C (C,D)	10-	---	---	---		MCTL163	25	04	
	650	Versys	LE650E	15-	---	---	---		MCTL163	25	04	
Z	750	/S	ZR750J	04-06	MCHL110	30	03		MCTL103	30	03	
Z	750	/S	ZR750L	07-12	MCHL123	30	03		MCTL106	30	03	
ZX-7R	750	Ninja	ZX750N (N,P)	96-	MCHL110	30	03		---	---	---	
Z	750	R	ZR750N	11-	MCHL123	30	03		MCTL106	30	03	
Z	750	R	ZR750P	11-	MCHL123	30	03		MCTL106	30	03	
Z	800		ZR800A/C	12-	MCHL120	35	03		MCTL103	35	03	

							Typ				Typ	
						+ mm				- mm		
ZX-9 R	900	Ninja	ZX900C (C,D)	98-00	MCHL110	30	03		MCTL124	35	03	
ZX-9 R	900	Ninja	ZX900E (E,F)	01-03	MCHL110	30	03		MCTL124	35	03	
KLV	1000		VVBS	02-	MCHL144	30	03		MCTL111	25	03	
KLV	1000	Versys	LZT00A	11-	MCHL164	35	01		MCTL166	20	01	
Z	1000		ZRT00A	03-06	MCHL110	25	03		MCTL103	30	03	
Z	1000		ZRT00B (B,C)	07-	MCHL120	30	03		MCTL106	30	03	
Z	1000		ZRT00D (D,E)	10-	MCHL164	30	01		MCTL166	30	01	
Z	1000		ZRT00F	14-	MCHL169	30	01		MCTL177	30	01	9)
Z	1000	SX	ZXT00G	11-	MCHL164	30	01		MCTL166	30	01	
Z	1000	SX	ZXT00L	14-	MCHL164	30	01		MCTL166	30	01	
ZX-10R	1000	Ninja	ZXT00C	04-05	MCHL110	30	03		MCTL124	30	03	
ZX-10R	1000	Ninja	ZXT00D	06-07	MCHL110	30	03		MCTL141	25	03	
ZX-10R	1000	Ninja	ZXT00E	08-	MCHL163	25	03		MCTL150	25	03	
ZX-10R	1000	Ninja	ZXT00F	10	MCHL163	25	03		MCTL150	25	03	
ZX-10R	1000	Ninja	ZXT00J	11-	MCHL163	25	03		MCTL150	25	03	
ZX-12R	1200	Ninja	ZXT20A	01-	MCHL110	30	03		MCTL119	30	03	
KTM												
	125	Duke		11-	MCHL172	30	02	3)	MCTL180	40	02	3)
RC	125	Duke		14-	MCHL172	20	02	3)	MCTL180	30	02	3)
	125	Duke ABS		13-	MCHL172	30	02	3)	MCTL180	40	02	3)
	200	Duke ABS		12-	MCHL172	30	02	3)	MCTL180	40	02	3)
	350	Freeride		12-	---	---	---		MCTL162	35	10	3)
	390	Duke		13-	MCHL172	30	02	3)	MCTL180	40	02	3)
RC	390	Duke		14-	---	---	---		MCTL180	30	02	3)
LC4	620		KTM-4T-EGS	98-	MCHL154	25	03		MCTL130	25	03	
	640	Duke II	KTM DK II	99-	---	---	---		MCTL130	25	03	
	690	SM, Enduro	690 LC4	08-	---	---	---		MCTL162	35	10	3) 6)
	690	SMC	690 LC4	08-	---	---	---		MCTL162	35	10	3) 6)
	690	SMC R	690 LC4	11-	---	---	---		MCTL162	35	10	3) 6)
	690	Duke	A3	08-11	---	---	---		MCTL162	20	10	3) 6)
	690	SM	A2	08-	---	---	---		MCTL162	20	10	3) 6)
	990	Super Duke, R	LC8 EFI	05-	---	---	---		MCTL162	25	10	3) 6)
	990	SMT, SMR	LC8 EFI	10-	---	---	---		MCTL162	35	10	3) 6)
	1050	Adventure	KV4340	15-	---	---	---		MCTL162	35	10	3) 6)
	1190	Adventure	KV2940	13-	---	---	---		MCTL162	35	10	3) 6)
Suzuki												
GS	500	E/EU	GM51B	89-00	MCHL110	25	03		MCTL109	40	03	1)
GS	500	E/EU	GM51A	89-00	MCHL110	25	03		MCTL109	40	03	1)
GS	500	E/EU	VVBK	01-	MCHL110	25	03		MCTL109	40	03	1)
GS	500	E/EU	BK	03-	MCHL110	25	03		MCTL109	40	03	1)
GSF	600	Bandit	GN77B	95-99	MCHL120	35	03		MCTL106	35	03	6)
GSF	600	Bandit, S	VVA8	00-04	MCHL120	35	03		MCTL106	30	03	
GSR	600		VVB9	06-	MCHL105	30	03		MCTL114	30	03	2)
GSX	600	F	AJ	98-	---	---	---		MCTL104	30	03	
GSX-R	600		AD	97-00	MCHL122	25	03		MCTL111	25	03	
GSX-R	600		VVBG	01-03	MCHL123	25	03		MCTL106	30	03	
GSX-R	600		VVB2	04-05	MCHL123	25	03		MCTL106	30	03	
GSX-R	600		VVCE	06-07	MCHL137	25	07	3)	MCTL122	25	07	3)
GSX-R	600		VVVCV	08-	MCHL137	25	07	3)	MCTL122	25	07	3)
GSX-R	600		C3	11-	MCHL137	25	07	3)	MCTL122	25	07	3)
RF	600		GN76B	93-96	MCHL123	30	03		MCTL106	35	03	
SFV	650	Gladius	VVCX	09-	MCHL106	30	03		MCTL154	30	03	
DL	650	V-Strom	VVB1	04-06	MCHL144	30	03		MCTL111	30	03	
DL	650	V-Strom	VVB1	07-	MCHL144	30	03		MCTL111	30	03	
DL	650	V-Strom	C7	12-	MCHL141	30	03		MCTL111	30	03	
GSF	650	Bandit, S	VVB5	05-06	MCHL120	35	03		MCTL106	30	03	
GSF	650	Bandit, S	VVCJ	07-	MCHL120	35	03		MCTL106	30	03	
GSF	650	Bandit, S	VVCZ	09-	MCHL120	35	---		MCTL106	30	03	
GSX	650	F	VVCJ	08-	MCHL120	35	03		MCTL106	30	03	
SV	650		AV	99-02	MCHL124	30	03		MCTL107	30	03	
SV	650		VVBY	03-	MCHL144	25	03		MCTL108	30	03	
GSR	750		C5	11-	MCHL127	35	03		MCTL174	35	03	
GSX	750	F	AK	99-02	---	---	---		MCTL104	30	03	
GSX	750	F	VVAK	03-04	---	---	---		MCTL104	30	03	
GSX	750	F	VVAK	05-06	---	---	---		MCTL104	30	03	
GSX-R	750		GR77B	88-89	MCHL125	35	03		---	---	---	
GSX-R	750		GR77A	88-89	MCHL125	35	03		---	---	---	
GSX-R	750		GR7AB	90-91	MCHL125	35	03		---	---	---	
GSX-R	750		GR7BB	92-95	MCHL126	25	03		MCTL162	25	10	3) 6)
GSX-R	750		GR7BC	92-95	MCHL126	25	03		MCTL162	25	10	3) 6)
GSX-R	750		GR7DB	96-99	MCHL122	25	03		MCTL111	25	03	
GSX-R	750		VVBD	00-03	MCHL123	25	03		MCTL106	30	03	
GSX-R	750		VVB3	04-05	MCHL123	25	03		MCTL106	30	03	
GSX-R	750		VVCF	06-07	MCHL137	25	07	3)	MCTL122	25	07	3)
GSX-R	750		VVCW	08-10	MCHL137	25	07	3)	MCTL122	25	07	3)
GSX-R	750		C4	11-	MCHL137	25	07	3)	MCTL122	25	07	3)

						Typ				Typ	
					+ mm				- mm		
GSX	750	AE	98-01	MCHL129	35	04		---	---	---	
RF	900	GT73B	94-97	MCHL140	30	03		MCTL106	30	03	
DL	1000	V-Strom	VVBS	MCHL144	30	03		MCTL111	20	03	
DL	1000	V-Strom	DD	MCHL173	30	01		MCTL155	30	01	
GSX-S	1000	DG	15-	MCHL178	25	01		MCTL179	25	01	
GSX-R	1000	VVBL	01-02	MCHL123	25	03		MCTL106	30	03	
GSX-R	1000	VVBZ	03-04	MCHL123	25	03		MCTL106	30	03	
GSX-R	1000	VVB6	05-06	MCHL120	25	03		MCTL109	30	03	
GSX-R	1000	VVCL	07-08	MCHL137	25	07	3)	MCTL122	25	07	3)
GSX-R	1000	VVCY	09-	MCHL107	30	01		MCTL155	30	01	
GSX-R	1100	GV73B/C	89-92	MCHL125	35	03		MCTL104	25	03	
GSX-R	1100	GU75C	95-96	MCHL126	30	03		MCTL162	25	10	3) 6)
GSF	1200	Bandit	GV75A	MCHL110	35	03		MCTL109	35	03	
GSF	1200	Bandit	VVA9	MCHL110	35	03		MCTL109	35	03	
GSF	1200	Bandit	VVCB	MCHL110	35	03		MCTL109	35	03	
GSX	1200	A3	99-00	MCHL129	35	04		---	---	---	
GSF	1250	Bandit	VVCH	MCHL110	35	03		MCTL109	35	03	
GSX	1250	F, FA	VVCH	MCHL110	35	03		MCTL109	35	03	
GSX-R	1300	Hayabusa	VVA1	MCHL131	30	03		MCTL148	30	03	
GSX-R	1300	Hayabusa	VVA1	MCHL131	30	03		MCTL148	30	03	
GSX-R	1300	Hayabusa	VVCK	MCHL131	30	03		MCTL148	30	03	
GSX	1300	BK B-King	VVCR	MCHL105	30	03		MCTL112	30	03	
GSX	1400	VVBN	02-06	MCHL129	35	04		---	---	---	
Triumph											
	675	Daytona	D67LC	MCHL139	25	01		MCTL136	25	01	
	675	Daytona, R	H67	MCHL139	25	01		MCTL136	25	01	
	675	Str. Triple, R	D67LD	MCHL139	25	01		MCTL136	30	01	
	675	Str. Triple, R,	L67LR	MCHL139	25	01		MCTL136	30	01	
	675	Str. Triple, R,	L67LR	MCHL139	25	01		MCTL136	30	01	
	800	Tiger, XC	A08	MCHL122	30	03		MCTL126	35	03	
	800	Tiger, XRX, XCX	A082	MCTL186	30	03		MCHL180	30	03	
	885	Legend TT	T309RT	MCHL120	25	03		MCTL141	30	03	
	955	Speed Triple	T509	---	---	---		MCTL170	25	10	3) 6)
	955	Speed Triple i	595N	---	---	---		MCTL170	30	10	3) 6)
	955	Daytona	595N	---	---	---		MCTL170	40	10	3) 6)
	1050	Tiger	115NG	MCHL167	25	01		MCTL171	30	01	
	1050	Tiger Sport	115NG	MCHL167	25	01		MCTL171	30	01	
	1050	Speed Triple	515NJ	---	---	---		MCTL170	30	10	
	1050	Speed Triple	515NJ	---	---	---		MCTL170	30	10	
	1050	Speed Triple	515NV	---	---	---		MCTL159	25	01	
	1200	Trophy SE	V13VH	MCHL131	30	03		MCTL111	40	03	
Yamaha											
DT	125	R	4BL	---	---	---		MCTL137	25	03	
DT	125	R, RH, RN	DE03	---	---	---		MCTL137	25	03	
DT	125	RE / X	DE06	---	---	---		MCTL137	25	03	
YZF	125	R	RE06	---	---	---		MCTL149	30	03	7)
YZF	125	R	RE11	MCHL175	25	03		MCTL185	40	03	7)10)
YZF	125	MT	RE11	MCHL175	25	03		MCTL185	40	03	7)10)
FZR	600		3HE	MCHL122	30	03		---	---	---	
FZR	600		3RG	MCHL122	30	03		---	---	---	
FZR	600		3RH	MCHL122	30	03		---	---	---	
FZR	600		4JH	MCHL140	30	03		MCTL114	40	03	
FZR	600		4MH	MCHL140	30	03		MCTL114	40	03	
FZS	600	Fazer	RJ02	MCHL141	35	03		MCTL111	35	03	
FZ6	600	Fazer, S	RJ07	MCHL119	35	02	3)	MCTL138	35	02	3)
FZ6	600	Fazer S2	RJ14	MCHL119	35	02	3)	MCTL138	35	02	3)
XJ6	600	Diversion, ABS	RJ19	---	---	---		MCTL156	25	10	3) 6)
XJ6	600	Diversion, ABS	RJ22	---	---	---		MCTL156	25	10	3)
YZF	600	R6	RJ03	MCHL142	25	06		---	---	---	
YZF	600	R6	RJ05	MCHL152	25	06		MCTL120	30	06	
YZF	600	R6	RJ09	MCHL152	25	06		MCTL120	30	06	
YZF	600	R6	RJ11	MCHL143	25	03		MCTL126	30	03	
YZF	600	R6	RJ15	MCHL143	25	03		MCTL126	30	03	
YZF	600	Thundercat	4TV	MCHL140	30	03		---	---	---	
YZF	600	Thundercat	4CV	MCHL140	30	03		---	---	---	
YZF	600	Thundercat	4WD	MCHL140	30	03		---	---	---	
SZR	660		4SU	---	---	---		MCTL108	30	03	
MT-03	660		RM02	MCHL136	30	02	3)	MCTL152	25	07	3)
XT	660	X, R	DM01	MCHL159	35	03		MCTL140	30	03	
XT	660	Z Ténéré	DM02	MCHL131	30	03		MCTL165	35	03	
XT	660	Z Ténéré	DM04	MCHL131	30	03		MCTL165	35	03	
MT-07	700		RM04	---	---	---		MCTL125	25	10	
MT-07	700	Moto Cage	RM07	---	---	---		MCTL125	25	10	
YZF	750		4HN	MCHL123	25	03		MCTL106	30	03	
YZF	750		4HR	MCHL123	25	03		MCTL106	30	03	
YZF	750		4HT	MCHL123	25	03		MCTL106	30	03	

								Typ					Typ	
					+ mm						- mm			
FZ8	800	Fazer	RN25	10-	MCHL149	30	01				MCTL115	25	01	
MT09	850		RN29	13-	MCHL176	25	03				MCTL178	25	03	11)
MT09	850	ABS	RN29	13-	MCHL176	25	03				MCTL178	25	03	11)
MT09	850	ABS Tracer		15-	MCHL176	25	03				MCTL178	25	03	11)
MT09	850	ABS Street Rally		14-	MCHL176	25	03				MCTL178	25	03	11)
MT09	850	ABS Sport Tracker		14-	MCHL176	25	03				MCTL178	25	03	11)
TRX	850		4UN	96-	MCHL110	30	03				---	---	---	
TDM	900		RN08	02-	---	---	---				MCTL139	35	03	
TDM	900		RN11	03-	---	---	---				MCTL139	35	03	
TDM	900		RN18	06-	---	---	---				MCTL139	35	03	
XJ	900	Diversion	4PR	95-	---	---	---				MCTL111	35	03	
XJ	900	Diversion	4KM	95-	---	---	---				MCTL111	35	03	
FZR	1000		3LE	89-95	MCHL143	45	03				---	---	---	
FZR	1000		3LF, 3GM	89-95	MCHL143	45	03				---	---	---	
FZS	1000	Fazer	RN06	01-	MCHL144	30	03				MCTL108	30	03	
FZS	1000	Fazer	RN14	04-	MCHL144	30	03				MCTL108	30	03	
FZ-1	1000	Fazer	RN16	06-	MCHL149	30	01				MCTL115	25	01	
YZF	1000	R1	RN01	98-00	MCHL146	25	06				MCTL120	30	06	
YZF	1000	R1	RN04	01	MCHL146	25	06				MCTL120	30	06	
YZF	1000	R1	RN09	02-03	MCHL152	25	06				MCTL120	30	06	
YZF	1000	R1	RN12	04-05	MCHL134	25	01				MCTL145	30	01	
YZF	1000	R1	RN12	06	MCHL134	20	01				---	---	---	
YZF	1000	R1	RN19	07-08	MCHL160	25	06				MCTL153	25	06	
YZF	1000	R1	RN22	09-	MCHL146	35	06				MCTL157	30	06	
YZF	1000	Thunderace	4VD	95-98	MCHL143	40	03				---	---	---	
YZF	1000	Thunderace	4SV, 4VF	95-98	MCHL143	40	03				---	---	---	
BT	1100	Bulldog	RP04/RP05	01-05	MCHL131	30	03				MCTL128	30	03	
XTZ	1200	Ténére, ABS	DP01	10-	---	---	---				MCTL164	35	03	
XT	1200	Z Super Tenere	DP04	14-	MCHL170	35	03				MCTL164	35	03	
XT	1200	ZE	DP04	14-	MCHL179	25	03	12)			MCTL187	25	03	
XJR	1200		4PU	94-00	MCHL145	40	05				---	---	---	
FJR	1300		RP04	01-02	MCHL143	30	03				MCTL112	30	03	
FJR	1300		RP08	03-05	MCHL143	30	03				MCTL112	30	03	
FJR	1300		RP11	03-05	MCHL143	30	03				MCTL112	30	03	
FJR	1300		RP13	06-	MCHL163	25	03				MCTL150	25	03	
FJR	1300		RP23	13-	MCHL163	25	03				MCTL150	25	03	
XJR	1300		RP02	98-01	MCHL145	40	05				---	---	---	
XJR	1300	SP	RP06	02-03	MCHL145	40	05				---	---	---	
XJR	1300	SP	RP10	04-06	MCHL145	40	05				---	---	---	
XJR	1300	SP	RP19	07-	MCHL145	40	05				---	---	---	
MT-01	1670		RP12	06-	---	---	---				MCTL151	25	10	3) 6)
MT-01	1670		RP18	07-	---	---	---				MCTL151	25	10	3) 6)

- 01) Hauptständer muss entfernt werden
- 02) der Seitenständer ist gemäß Montageanleitung um ca. 15 mm zu kürzen
- 03) Federbein muß abgepresst werden, nur bei OE Federbein montierbar
- 04) Federbein muß abgepresst werden, nur bei OE Federbein o. einstellbare Zugstufe montierbar
- 05) für Modell mit Original-Umlenkhebel mit Lochabstand größer als 100 mm
- 06) Federvorspannung anpassen
- 07) die Zahl der Sitzplätze ist auf 1 reduziert, nicht mit Sozius
- 08) Auspuffschelle und Blende bei Montage lösen
- 09) Absenkung der Telegabel möglich
- 10) Spritzschutz Hinterrad entfernen
- 11) Seitenständer um 10 mm kürzen bei abgesenkter Telegabel bei 20 mm
- 12) Hauptständer muß angepasst werden

- 01) main stand has to be removed
- 02) the side stand has to be shortened by approx. 15 mm according to mounting instructions
- 03) the strut has to be pressure tested, can be mounted only with OE strut
- 04) the strut has to be pressure tested, can be mounted only with OE strut without adjustable tension level
- 05) for model with original relay arm with hole spacing over 100 mm
- 06) adapt pre-tension of spring
- 07) The number of seats is reduced to 1, not with pillion
- 08) Release exhaust clamp and cover for installation
- 09) Lowering of front fork possible
- 10) Remove mud guard on rear wheel for fitting
- 11) Shorten side stand by 10 mm, by 20 mm with lowered front fork
- 12) Main stand has to be modified

- 01) le support principal doit être retiré.
- 02) les béquilles latérales doivent être raccourcies d'env. 15 mm conformément aux instructions de montage.
- 03) la jambe de suspension doit être démontée ; montage possible uniquement avec les jambes de suspension OE
- 04) la jambe de suspension doit être démontée ; montage possible uniquement avec les jambes de suspension OE ou les niveaux de tirage réglable.
- 05) pour les modèles avec levier de renvoi d'origine, avec écarts de plus de 100 mm entre les trous
- 06) adapter la précontrainte du ressort.
- 07) Le nombre de places assises est réduit à 1, pas de passager
- 08) Desserrer le collier d'échappement et le panneau lors du montage
- 09) Fourche télescopique abaissable
- 10) Enlever la protection anti-projections de la roue arrière
- 11) Raccourcir les béquilles de 10 mm, de 20 mm lorsque la fourche télescopique est abaissée
- 12) Le support principal doit être adapté

Typen der Höhenänderung:

- 01 Dreiecksplatten
- 02 Aufnahme für Federbeinauge
- 03 Zugstrebe
- 04 Distanzstück (Frästeil) für Stereofederbeine
- 05 Distanzstück (Frästeil) für Stereofederbeine
- 06 Zugstrebe
- 07 Aufnahme für Federbeingabel
- 08 Zugstrebe
- 09 Federbeinaufnahme BMW
- 10 Federteller

Type of height change:

- 01 Triangle plates
- 02 Seating for strut eye
- 03 Tie rod
- 04 Spacer (milled part) for stereo shocks
- 05 Spacer (milled part) for stereo shocks
- 06 Tie rod
- 07 Seating for strut fork
- 08 Tie rod
- 09 Strut seating BMW
- 10 Spring plate

Types de modifications de hauteur:

- 01 Plaques triangulaires
- 02 Logement pour oeil de jambe de suspension
- 03 Tirant
- 04 Pièce d'écartement (pièce fraisée) pour jambes de suspension doubles
- 05 Pièce d'écartement (pièce fraisée) pour jambes de suspension doubles
- 06 Tirant
- 07 Logement pour la fourche de la jambe de suspension
- 08 Tirant
- 09 Logement pour jambe de suspension BMW
- 10 Coupelle de ressort



KENNZEICHENHALTER

*SUPPORT POUR PLAQUE
REGISTRATION PLATE HOLDERS*

KENNZEICHENHALTER *SUPPORT POUR PLAQUE* REGISTRATION PLATE HOLDERS



Formschöner, leichter Kennzeichenhalter

- » sehr edel aus Aluminium, schwarz beschichtet
- » inkl. aller Montageteile, einfach an den Originalpunkten zu montieren
- » alle Nummernschildhalter werden, wenn nicht anders angegeben, ohne Beleuchtungselemente geliefert
- » wo nötig, die Kennzeichenleuchte MSH 900 + MSH 902 auswählen (siehe Seite 5.60)
- » bei den meisten Modellen können die Original-Blinker nicht verwendet werden

Attractively formed, lightweight registration plate holder

- » high quality aluminium, with black coating
- » includes all components, easy to mount at the original points
- » unless otherwise indicated, all registration plate holders will be supplied without lighting elements
- » where necessary, select the registration plate bulb MSH 900 + MSH 902 (see page 5.60)
- » for most models, the original indicators cannot be used

Support pour plaque élégant et léger

- » support pour plaque d'immatriculation en aluminium, avec revêtement noir
- » toutes les pièces de montage sont incluses pour un montage plus simple aux points d'origines
- » sauf mention contraire, tous les supports pour plaque d'immatriculation sont fournis sans éclairage
- » en cas de besoin, choisir les feux d'éclairage MSH 900 + MSH 902 (cf. page 5.60)
- » l'éclairage d'origine de la plaque d'immatriculation et le clignotant d'origine ne peuvent pas être utilisés sur la plupart des modèles

EINBAUBEISPIELE EXEMPLES D'INSTALLATION INSTALLATION EXEMPLES



Beispielbild Kennzeichenhalter mit LED-Leuchte integriert:

- » Rücklicht
- » Bremslicht
- » Schildbeleuchtung

Sample image for registration plate holder with integrated LEDs:

- » Tail light
- » Brake light
- » Plate light

Exemple Support pour plaque d'immatriculation avec éclairages LED intégrés :

- » Feu arrière
- » Feu de stop
- » Éclairage de plaque



Bestell-Nr.
Order no.
N° comm.

MSH400

Universalhalter zum Selbsteinpassen
Universal holder, can be adjusted to fit all makes
Support universel qui s'ajuste aux besoins individuels



Bestell-Nr.
Order no.
N° comm.

MSH401

Vario-Universalhalter, verstellbar
Variable universal holder, adjustable
Support universel variable, réglable



Schraubenset 15-tlg mit M5-Gewinde, zur Montage des Nummernschildes
15 part M5 screw set, for correct mounting of the registration plate
Set de 15 vis avec filetages M5, pour un montage professionnel de la plaque d'immatriculation

Bestell-Nr.
Order no.
N° comm.

MSH901



Bestell-Nr.
Order no.
N° comm.

MSH900

Nummernschild - beleuchtung
registration plate lighting
Eclairage pour plaque d'immatriculation



Bestell-Nr.
Order no.
N° comm.

MSH902

Nummernschild - beleuchtung LED, gefrästes Alugehäuse
LED registration plate lighting, milled aluminum frame
Eclairage LED pour plaque d'immatriculation avec boîtier en aluminium fraisé









Bestell-Nr.
Order no.
N° comm.

MSH903

Universal-Beleuchtung, zur Montage an der Heckunterverkleidung.
Universal light, for mounting on the lower side of rear fairing.
Éclairage universel, pour montage sous la coque arrière.

						MSH900	MSH902		
BMW									
S	1000	RR		09-	MSH 130	Original			
S	1000	R		14-	MSH 130	Original			
Ducati									
	848	Streetfighter		11-	MSH 120	---			5) - MSH903
	1098	Streetfighter		09-	MSH 120	---			5) - MSH903
Honda									
CBR	600	F	PC41	11-	MSH 106	Original			3)
CB	600	Hornet	PC41	11-	MSH 106	Original			3)
CBR	600	RR	PC37	03-04	MSH 100	MSH 900	MSH 902		
CBR	600	RR	PC37	05-06	MSH 103	MSH 900	MSH 902		

						 MSH900	 MSH902	
NC	700	S	RC61	12-	MSH 110	inkl. LED Leuchte		1), 2)
NC	700	X	RC63	12-	MSH 110	inkl. LED Leuchte		1), 2)
CBR	954	RR	SC50	02-03	MSH 101	Original		
CBR	1000	RR	SC57	04-07	MSH 102	MSH 900	MSH 902	4)
CBR	1000	RR	SC59	08-09	MSH 105	Original		3)
CB	1000	R	SC60	08-	MSH 106	Original		3)
Kawasaki								
ER-6	650	N	ER650A	06-08	MSH 203	MSH 900	MSH 902	
ER-6	650	F	EX650A	06-08	MSH 203	MSH 900	MSH 902	
ER-6	650	F	EX650C	09-11	MSH 208	MSH 900	MSH 902	
ER-6	650	F	EX650E	12-	MSH 210	---		2), 5) - MSH903
ZX-6R	600	RR Ninja	ZX600K	03-	MSH 200	MSH 900	MSH 902	
ZX-6R	636	Ninja	ZX600B	03-04	MSH 200	MSH 900	MSH 902	
ZX-6R	636	Ninja	ZX600C	05-06	MSH 202	MSH 900	MSH 902	
ZX-6R	600	Ninja	ZX600P	07-08	MSH 205	inkl. LED Leuchte		1)
ZX-6R	600	Ninja	ZX600R	09-12	MSH 207	Original		
ZX-6R	636	Ninja	ZX636F	13-	MSH 207	Original		
Z	750		ZR750J	04-06	MSH 200	MSH 900	MSH 902	
Z	750		ZR750L	07-10	MSH 206	MSH 900	MSH 902	
Z	750	R	ZR750N	11-12	MSH 206	MSH 900	MSH 902	
Z	800	R	ZR800A	13-	MSH 211	---		2), 5) - MSH903
Z	1000		ZRT00A	03-06	MSH 200	MSH 900	MSH 902	
Z	1000		ZRT00B	07-09	MSH 206	MSH 900	MSH 902	
Z	1000		ZRT00C, D	10-13	MSH 209	MSH 900	MSH 902	
Z	1000			14-	MSH 213	---	---	2), 5) - MSH903
Z	1000	SX	ZXT00G	11-13	MSH 209	MSH 900	MSH 902	
Z	1000	SX	ZXT00G	14-	MSH 214	---	---	2), 5) - MSH903
ZX-10R	1000	Ninja	ZXT00C	04-05	MSH 201	MSH 900	MSH 902	
ZX-10R	1000	Ninja	ZXT00D	06-07	MSH 204	MSH 900	MSH 902	
ZX-10R	1000	Ninja	ZXT00E	08-10	MSH 207	Original		
ZX-10R	1000	Ninja	ZXT00F	11-	MSH 212	MSH 900	MSH 902	
Suzuki								
GSXR	600		WVB2	04-05	MSH 302	MSH 900	MSH 902	
GSXR	600		WCE	06-07	MSH 305	MSH 900	MSH 902	
GSXR	600		WVCV	08-10	MSH 307	MSH 900	MSH 902	
GSXR	600		WVC3	11-	MSH 310	MSH 900	MSH 902	
SV	650		WVBY	03-	MSH 300	Original		
GSR	750		C5	11-	MSH 311	MSH 900	MSH 902	
GSXR	750		WVB3	04-05	MSH 302	MSH 900	MSH 902	
GSXR	750		CF	06-07	MSH 305	MSH 900	MSH 902	
GSXR	750		WVCW	08-10	MSH 307	MSH 900	MSH 902	
GSXR	750		WVC4	11-	MSH 310	MSH 900	MSH 902	
GSXR	1000		WVBZ	03-04	MSH 301	Original		
GSXR	1000		WVB6	05-06	MSH 303	MSH 900	MSH 902	
GSXR	1000		WVCL	07-08	MSH 303	MSH 900	MSH 902	
GSXR	1000		WVCY	09-	MSH 309	MSH 900	MSH 902	
SV	1000		WVBX	03-	MSH 300	Original		
GSX	1300	B-King	WVCR	07-	MSH 308	inkl. LED Leuchte		1)
Triumph								
	1050	Speed Triple	515NJ	05-07	MSH 600	Original		
Yamaha								
FZ6	600	N	RJ07	04-	MSH 503	MSH 900	MSH 902	
XJ6	600	F Diversion	RJ19	09-	MSH 508	MSH 900	MSH 902	
YZF	600	R6	RJ03	01-02	MSH 501	MSH 900	MSH 902	
YZF	600	R6	RJ05, RJ09	03-05	MSH 500	MSH 900	MSH 902	
YZF	600	R6	RJ11	06-11	MSH 504	MSH 900	MSH 902	
MT-07	700	RM04	RM04	14-	MSH 509	---	---	2), 5) - MSH903
FZ8	800	, Fazer	RN25	10-	MSH 505	MSH 900	MSH 902	
MT-09	850		RN29	13-	MSH 510	---	---	2), 5) - MSH903
FZ1	1000	N	RN16	06-	MSH 505	MSH 900	MSH 902	
YZF	1000	R1	RN09	02-03	MSH 500	MSH 900	MSH 902	
YZF	1000	R1	RN12	04-06	MSH 502	MSH 900	MSH 902	
YZF	1000	R1	RN19	07-08	MSH 506	MSH 900	MSH 902	
YZF	1000	R1	RN22	09-	MSH 507	MSH 900	MSH 902	

- 1) inkl. LED - Rücklicht und LED - Kennzeichenbeleuchtung
2) Neigung verstellbar
3) inkl. Seitenverstrebung
4) Seitenverkleidung v. Auspuff muss entfernt werden
5) Original Kennzeichenleuchte durch eine Variante zur Montage unter Heckverkleidungen ersetzen

- 1) incl. LED rear light and LED registration plate lighting
2) Inclination adjustable
3) incl. side braces
4) exhaust side cover must be removed
5) replace original number plate light with a version for mounting on the lower side of rear fairings

- 1) avec feu arrière LED et éclairage LED de la plaque d'immatriculation
2) Inclinaison réglable
3) avec renfort latéral
4) le revêtement latéral devant l'échappement doit être retiré.
5) remplacer l'éclairage de plaque d'immatriculation d'origine par un modèle à monter sous la coque arrière.

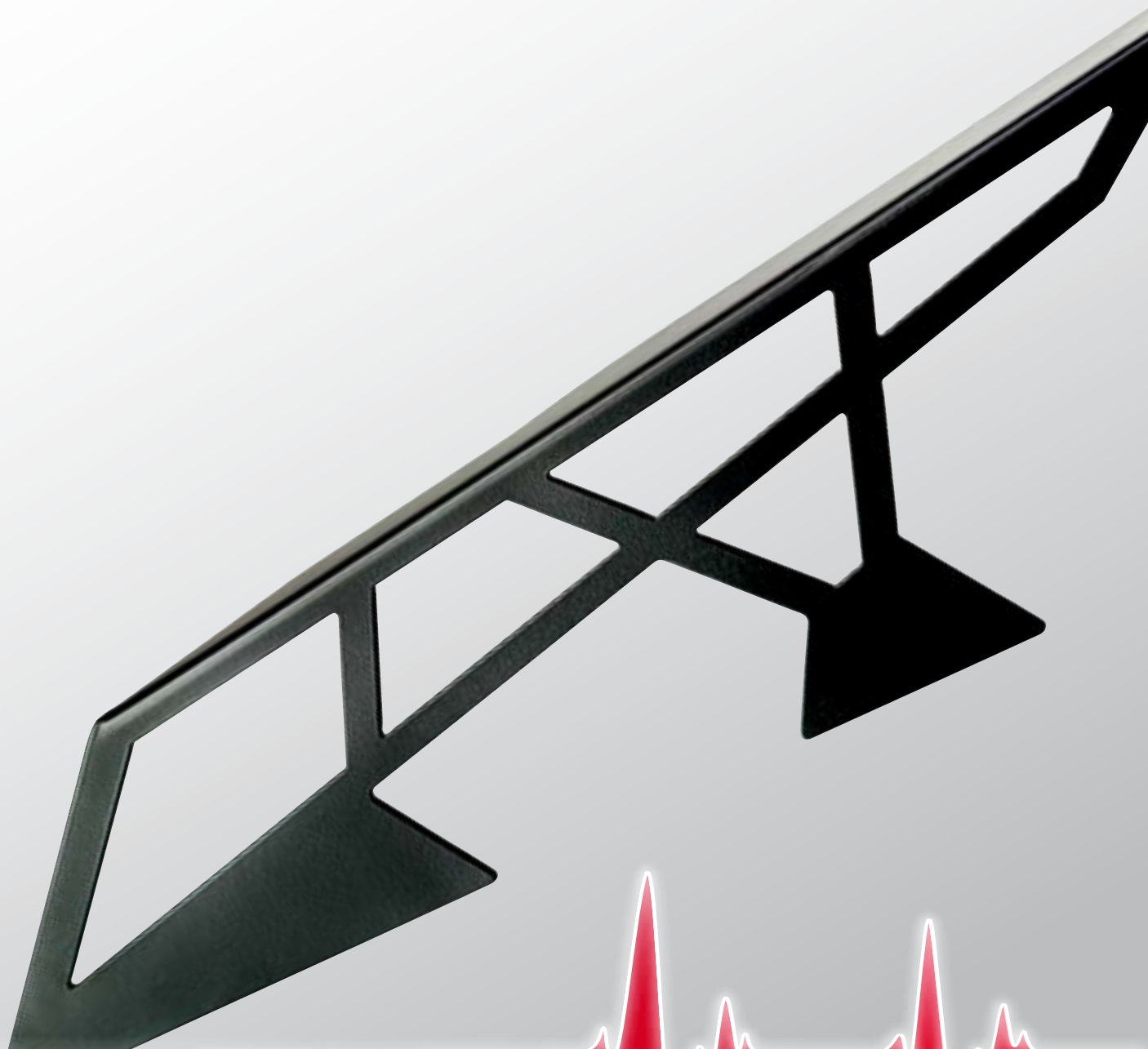

KETTENSCHÜTZER

PROTECTION DE CHAÎNE

CHAIN GUARDS

KETTENSCHÜTZER

PROTECTION DE CHAÎNE CHAIN GUARDS

Kettenschützer aus Aluminium

- » formschönes, attraktives Design
- » hochwertige Ausführung
- » metallische Pulverbeschichtung
- » korrosionsgeschützte Oberfläche
- » leicht zu reinigen und zu pflegen
- » stabile, passgenaue Konstruktion

Aluminium chain guard

- » attractive design with beautiful lines
- » high-quality product
- » metallic powder coating
- » corrosion-resistant surface
- » easy to clean and maintain
- » robust, accurately-fitting design

Protection de chaîne en aluminium

- » design attractif et ergonomique
- » Modèle de grande qualité
- » revêtement par poudre, métallique
- » surface protégée contre la corrosion
- » facile à nettoyer et à entretenir
- » construction stable et ajustée



Passend für fast alle Modelle ohne Schwingenoberzug!

Fits most models without top-mounted stabiliser on swingarm!

Convient pour presque tous les modèles, sans revêtement sur la bielle oscillante!

Silber silver argent	Schwarz black noir
MCK2222	MCK2222-S

Universal-Kettenschutz mit maximalem Befestigungsbereich von 377 mm.

Universal chainguard with maximum fitting range of 377 mm.

Protection de chaîne universelle avec distance maximale entre les 2 points de fixation de 377 mm.

